



UNIVERSITY
OF WOLLONGONG
AUSTRALIA

University of Wollongong
Research Online

Faculty of Engineering - Papers (Archive)

Faculty of Engineering and Information Sciences

2008

A systematic approach towards evaluating voltage unbalance problem in interconnected sub-transmission networks: separation of contribution by lines, loads and mitigation

Prabodha Paranavithana

University of Wollongong, ptp123@uow.edu.au

Sarath Perera

University of Wollongong, sarath@uow.edu.au

Danny Soetanto

University of Wollongong, soetanto@uow.edu.au

Robert Koch

Eskoms Research and Innovation Centre

<http://ro.uow.edu.au/engpapers/5401>

Publication Details

P. Paranavithana, S. Perera, D. Soetanto & R. Koch, "A systematic approach towards evaluating voltage unbalance problem in interconnected sub-transmission networks: separation of contribution by lines, loads and mitigation," in ICHQP 2008: 13th International Conference on Harmonics & Quality of Power, 2008, p. [6].

Research Online is the open access institutional repository for the University of Wollongong. For further information contact the UOW Library: research-pubs@uow.edu.au

A Systematic Approach Towards Evaluating Voltage Unbalance Problem in Interconnected Sub-transmission Networks: Separation of Contribution by Lines, Loads And Mitigation

Prabodha Paranavithana, *Student Member, IEEE*, Sarath Perera, *Member, IEEE*,
Danny Sutanto, *Senior Member, IEEE*, and Robert Koch

Abstract—The levels of voltage unbalance which exist in some interconnected sub-transmission systems in Australia have been observed to exceed the stipulated levels. The causes of the problem are not well known to system operators, ie. whether the problem mainly arises as a result of system asymmetry or loads or both. Hence, system operators have found difficulties in identifying potential mitigation approaches which provide the optimum level of correction at various busbars. This paper reports, employing a study network, a suitable theoretical basis that can be used to identify the level of contribution made by the asymmetrical transmission lines and the unbalanced loads in relation to the problem of voltage unbalance and a systematic approach for identifying the optimum mitigation options.

Index Terms—voltage unbalance, interconnected sub-transmission systems, network asymmetry, unbalanced loads

I. INTRODUCTION

VOLTAGE unbalance has been noted to be a power quality problem of concern in some sub-transmission systems in Australia. Although there are applicable regulatory codes such as the National Electricity Code (NEC) [1] and the Electricity Distribution Code (EDC) [2], some service providers are facing difficulties in maintaining the stipulated levels. The NEC specifies that the voltage unbalance be limited at 0.5% for systems operating at or above 100kV, 1.3% for systems operating between 10kV and 100kV and 2.0% for 10kV and lower voltage systems when determined over a 30-minute averaging period. According to the EDC, a distributor is obliged to limit the negative sequence voltage at the point of common coupling of a customer's three-phase electrical installation $\leq 1\%$ allowing excursions up to 2% for a total of 5 minutes in every 30-minute period.

The 66kV interconnected sub-transmission system under study which has to satisfy the EDC requirements has been noted to exhibit voltage unbalance levels up to 2% at some busbars during the peak demand periods. Although efforts have been put to address the issue by balancing the loads

at some of the busbars, no significant improvements have been noted leaving the asymmetry of the various untransposed lines as the primary contributor to the problem. However, the interconnected nature of the network makes identification of contributors to the problem, and hence decision making on suitable mitigation options a challenging task.

The work presented in this paper is an extension to [3] and [4] presenting deterministic approaches that can be applied to develop an insight into the role played by the asymmetrical lines of the interconnected system under study. The main objective of this paper is to develop a theoretical basis to identify the level of contribution made by the asymmetrical lines and the loads towards the voltage unbalance problem in hand, and hence to propose a systematic approach for identifying the optimum mitigation options.

The paper is organised as follows: The interconnected 66kV sub-transmission system under study is introduced in Section II. Section III briefly gives the results and outcomes of the analysis presented in [3] and [4]. An analysis carried out in relation to the asymmetry associated with the loads is presented in Section IV. Section V addresses the resultant nodal voltage unbalance arising as a result of the interaction of both the asymmetrical network and the unbalanced loads, and identifies the leading contributors to the problem. A number of mitigation approaches are systematically identified in Section VI. Conclusions are given in Section VII.

II. INTRODUCTION TO STUDY SYSTEM

The 66kV sub-transmission system under study shown in Fig. 1 is connected to the EHV transmission system at S1 (bulk supply point) where the voltage unbalance has been measured to be negligible. Some of the transmission lines of the system are longer than 50km and are not systematically transposed (it is not a general practice to transpose at this voltage level). The system supplies major customers including irrigators who use three-phase induction motor driven pump systems. The levels of voltage unbalance that exist at load busbars S7, S8 and S9 have been noted to exceed 2%, in addition to the significant levels (1.2%) even at upstream busbars S2 and S4 during the peak demand periods. Initial studies have revealed that significant degree of load asymmetry existed at busbars S7 and S8. In general, the voltage unbalance levels in the system

Prabodha Paranavithana, Sarath Perera and Danny Sutanto are with the School of Electrical, Computer and Telecommunications Engineering, University of Wollongong, and are Members of the Integral Energy Power Quality and Reliability Centre, NSW 2522, Australia (email: ptp123@uow.edu.au).

Robert Koch is with Eskom Holdings Limited, Resources and Strategy Division, Eskom Research and Innovation Centre, Private Bag 40175, Cleveland, 2022, South Africa.

have decreased after balancing the loads at these busbars, but the improvement has not been significant enough to bring these levels below the code requirements.

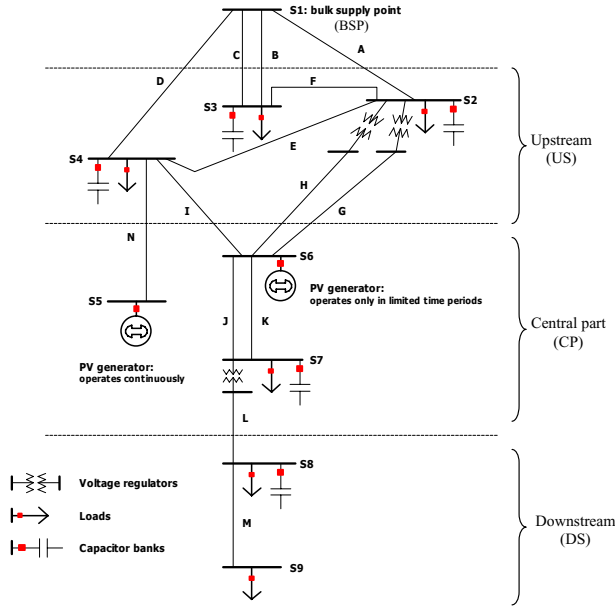

Fig. 1. 66kV sub-transmission system under study

III. ANALYSIS OF NETWORK ASYMMETRY [3], [4]

The voltage unbalance behaviour of the asymmetrical sub-transmission network was initially quantified in terms of voltage unbalance factor (VUF) at the various busbars using a three-phase power flow analysis [3] - [5]. This was accomplished by synthesising the actual system operation with balanced constant PQ type loads. Fig. 2 illustrates the results obtained with respect to a selected time stamp which lies within the system peak. This reveals that the asymmetry of the network alone introduces considerable levels of voltage unbalance at the downstream busbars (S8 and S9 - 1.4%) and also at the busbars located in the central part (S6 and S7 - 1%) of the network. The influence of the asymmetrical lines is seen to prevail even at the upstream busbars (S2 and S4 - 0.5%) but to a lower degree compared to the busbars listed above. These results suggest that the asymmetry associated with the lines is a potential factor contributing to the voltage unbalance levels above the code requirements.

A. Voltage unbalance behaviour of individual lines

The objective of the study presented in this section is to observe the voltage unbalance behaviour of the individual lines of the study network when operating in the interconnected environment. This is facilitated by establishing the ‘negative sequence voltage emission vectors’ a concept which is derived from IEC/TR 61000-3-13 [6]. For this the transmission line of which the influence is to be observed (‘transmission line under observation’) at the various busbars is parameterised based on its actual construction while the other lines are parameterised assuming they are ideally transposed. Further, the system is

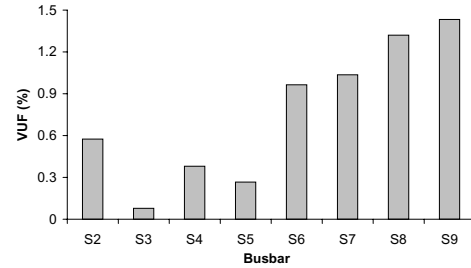

Fig. 2. Nodal voltage unbalance levels arising as a result of the asymmetrical network

operated at the selected time stamp with balanced PQ type loads.

Fig. 3 shows the resulting VUF values (ie. magnitudes of emission vectors) arising at the various busbars (S2 - S9 of Fig. 1) by applying each of the lines (one at a time) as a line under observation. It is seen that lines A, D, F, I and J lead to relatively high levels of voltage unbalance emission in an average sense. It can be noted that the impact of lines E, G, H and K are negligible, whereas the influence of lines B, C, L, M and N are moderate. These results have been analysed in detail by giving attention to the line asymmetry ($|Z_{-+}|$, where Z_{-+} is the coupling impedance between negative and positive sequence networks of a line), line loading level ($|I_+|$, where I_+ is the positive sequence current in a line) and location of line in the network [3] - [4]. The term representing the product $|Z_{-+}I_+|$ of a line and the location of that line in the network were identified as the features which influence the voltage unbalance levels at the various busbars.

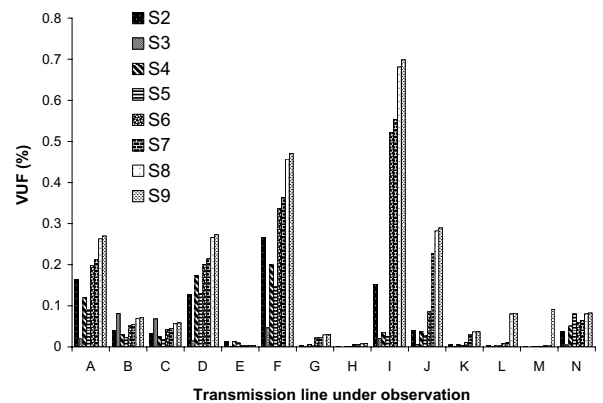

Fig. 3. Nodal voltage unbalance levels caused by the individual transmission lines

Fig. 4 illustrates the phase angles (θ_{Line_i}) of negative sequence voltages at busbars S2, S4 and S6 - S9 (most affected busbars as seen in Fig. 2) caused by individual lines under observation A - D, F, I, J and L - N (which introduce considerable emissions as noted in Fig. 3). It is seen from Fig. 4 that the above individual lines lead to a unique and nearly constant phase angle across all the busbars. It has also been noted that the angle θ_{Line_i} can be derived using the

vector component $-Z_{-+}I_+$ associated with the line under observation.

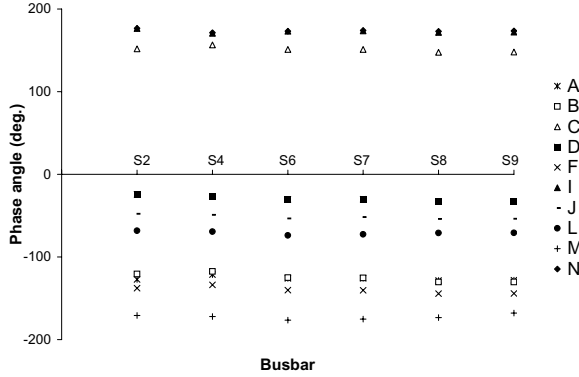

Fig. 4. Phase angles of nodal negative sequence voltages caused by the individual lines

Combining the results presented in Fig. 3 (magnitudes of emission vectors) and Fig. 4 (phase angles of emission vectors), the overall voltage unbalance behaviour of the individual lines can be represented using Fig. 5 which illustrates the emission vectors of the individual lines (A - D, F, I, J and L - N) of which the emission levels were significant. It is seen that Fig. 5 providing a complete picture of the role played by the asymmetrical network in relation to the problem can also be established intuitively by observing the impedance Z_{-+} (magnitude and phase angle), loading level ($|I_+|$) and location in the network of the individual lines.

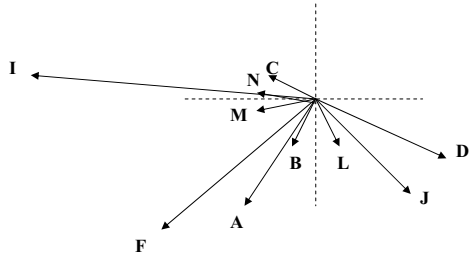

Fig. 5. Representation of overall voltage unbalance behaviour of the individual lines

IV. ANALYSIS OF LOAD ASYMMETRY

Table I gives the active and reactive power distribution across the three-phases at the various load busbars of the study network corresponding to the considered time stamp. It also gives the degree of asymmetry associated with the real power of loads using the standard deviation (rows 6).

The voltage unbalance behaviour of the unbalanced loads alone can be established by applying the loads as given in Table I and by parameterising the lines assuming they are ideally transposed. Fig. 6 illustrating the results obtained for VUFs at the various busbars reveals that the impact of the loads acting alone is also considerable (highest VUF: 1% at S9) and an issue that needs attention.

TABLE I
POWER DISTRIBUTION ACROSS THE THREE-PHASES AT THE VARIOUS LOAD BUSBARS

Load busbar	S2	S3	S4	S7	S8	S9
P_a (MW)	6.32	6.24	3.87	11.3	2.04	0.57
P_b (MW)	5.87	6.08	3.43	11.3	1.89	0.55
P_c (MW)	5.87	5.96	3.37	11.38	2.04	0.54
$Q_a \approx Q_b \approx Q_c$ (MVar)	0.12	2.37	1.705	4.84	0.63	0.08
Standard deviation of P_a, P_b and P_c (μP)	0.26	0.14	0.27	0.05	0.09	0.02

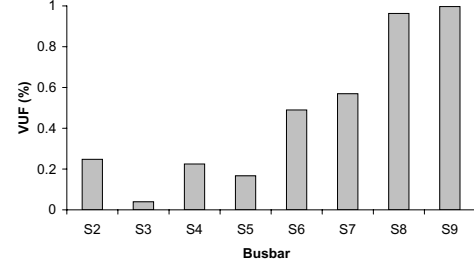

Fig. 6. Nodal voltage unbalance levels arising as a result of the unbalanced loads alone

A. Voltage unbalance behaviour of individual loads

As in the case of approach taken to investigate the impact of individual asymmetrical lines, the impact of the individual loads can be obtained by considering a single load at a time ('load under observation') whereby it is applied as defined in Table I while all the other loads and the network are parameterised to represent a balanced behaviour.

Arising as a result of a load under observation (labelled L_i) the negative sequence voltage emission vector at any busbar has to satisfy (1):

$$V_{-, \text{receiving end of } Y} = V_{-, \text{sending end of } Y} - Z_{+, Y} I_{-, Y/L_i} \quad (1)$$

where,

$I_{-, Y/L_i}$ - negative sequence current in any line Y caused by L_i

Fig. 7 illustrates the resulting VUF values arising at the various busbars (S2 - S9) by applying each of the unbalanced loads (one at a time) as a load under observation. The loads supplied by busbars S2, S4 and S8 seem to cause relatively high levels of voltage unbalance emission. The influence of the loads supplied by busbars S7 and S9 is moderate while the impact of the load supplied by busbar S3 is seen to be negligible.

Based on the results in Fig. 7 in relation to the individual loads, Table II provides a rank (column 5) on their voltage unbalance emission levels together with other important information such as their locations in the network (column 4). For brevity, the information given in Table I are repeated providing a commentary on the degree of asymmetry associated with the real power component (columns 2) and the three phase loading level (column 3).

The entries in Table II suggest that the loading level is not a factor which governs the level of emission. The load supplied by busbar S8 located at the downstream of the system is seen to cause the highest level of emission in an average sense, although the associated degree of load asymmetry ($\mu_P = 0.09$) is considerably lower than that of the loads supplied by busbars S2 and S4 ($\mu_P \approx 0.26$) located at the upstream. It is therefore evident that the loads supplied by the busbars located at the downstream of the system tend to introduce increased emission levels compared to those located at the upstream for a similar degree of asymmetry. In contrary, the level of emission of the load supplied by busbar S9 which is associated with only a very low degree of asymmetry ($\mu_P = 0.02$) is seen to be low although it is located at a point further downstream of the load at busbar S8 which leads to the highest emission level. Based on these observations it can be concluded that the degree of load asymmetry and the location of the load busbar in the network are the factors that needs consideration when evaluating the voltage unbalance emission levels introduced by individual loads.

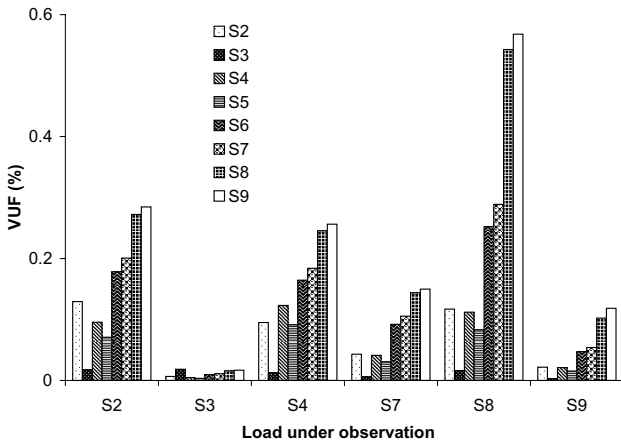

Fig. 7. Nodal voltage unbalance levels caused by the individual loads

Fig. 8 illustrates the phase angles (θ_{L_i}) of negative sequence voltages at the busbars (S2 - S9) caused by individual loads at S2, S4, S7 - S9 (which introduce considerable emissions as noted in Fig. 7). Fig. 8 indicates that the above individual loads yield a unique and nearly constant phase angle across all the busbars. These results are in agreement with (1) which explains that the phase angles θ_{L_i} arising as a result of a load under observation at the various busbars should be associated with the vector component $-Z_{++Y}I_{-,Y/L_i}$. The phase angle of the impedance Z_{++Y} depends only on the X/R ratio of any line Y which have been noted to be nearly identical for all the lines in the network. The phase angle of the negative sequence current $I_{-,Y/L_i}$ is primarily determined by the order of the active power distribution across the three-phases of load L_i . Hence, the angles θ_{L_i} at the various busbars remain similar and unique for a particular load under observation.

A complete picture of the role played by the unbalanced loads in relation to the problem in hand can be illustrated

TABLE II
OPERATING FEATURES AND EMISSION LEVELS OF THE INDIVIDUAL LOADS

Load busbar	Degree of asymmetry (μ_P)	Three-phase loading (MW/MVAr)	Location in the network	Level of emission
S4	High (0.27)	High (11/5.115)	US	High
S2	High (0.26)	Very high (18/0.36)	US	High
S3	Low (0.14)	Very high (18/7.11)	US: a remote busbar	Negligible
S8	Low (0.09)	Low (6/1.89)	DS	Very high
S7	Very low (0.05)	Extra high (34/14.52)	CP	Low
S9	Very low (0.02)	Very low (2/0.08)	DS	Low

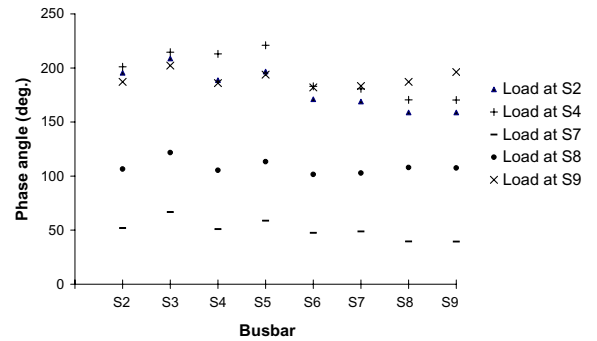

Fig. 8. Phase angles of nodal negative sequence voltages caused by the individual loads

using Fig. 9 which shows the emission vectors representing both the magnitudes (as identified in Table II: column 5) and the phase angles (Fig. 8) of the individual loads (supplied by busbars S2, S4, S7 - S9) of which the emission levels were significant. It is seen that Fig. 9 representing the overall voltage unbalance behaviour of the individual loads can also be established intuitively by examining the degree of asymmetry (μ_P), order of the power distribution across the three-phases and location in the network.

V. COMBINED IMPACT OF NETWORK AND LOAD ASYMMETRY

The resultant voltage unbalance behaviour of the system when both the asymmetrical network and the unbalanced loads operate simultaneously can be established by applying the loads as given in Table I and by parameterising the lines based on their actual construction. Fig. 10 illustrates the resulting VUF values at the various busbars, in comparison to the impact of the network (Fig. 2) and the unbalanced loads (Fig. 6) alone. Fig. 10 also illustrates the VUF values derived using the field measurements (not available for some of the busbars). It is evident that the interaction of the network and the loads causes

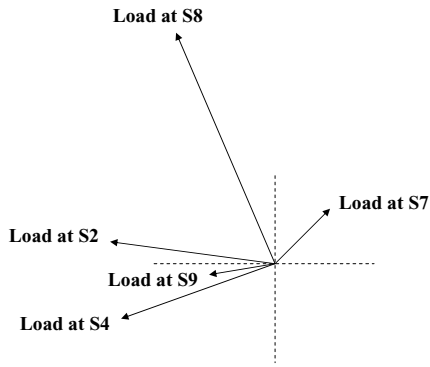

Fig. 9. Representation of overall voltage unbalance behaviour of the individual loads

voltage unbalance levels up to $\sim 1.8\%$ at busbars S8 and S9 (upstream), $\sim 1.2\%$ at S6 and S7 (central part) and $\sim 0.6\%$ at S2 and S4 (downstream), which are seen to be in close agreement with the measured values.

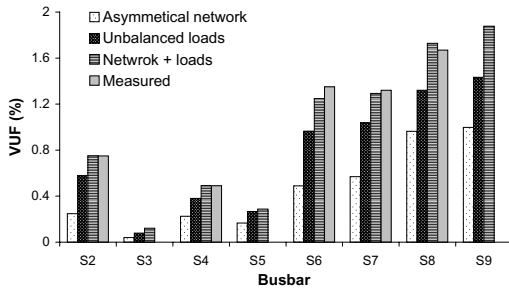

Fig. 10. Nodal voltage unbalance levels arising as a result of the interaction of the asymmetrical network and the unbalanced loads in comparison to that caused alone by the asymmetrical network and the unbalanced loads, and also to the measured values

Fig. 11 illustrates the individual contributions made by the network and the loads to the resultant voltage unbalance levels at busbars S2, S4 and S6 - S9 (the critical busbars as noted in Fig. 10) derived employing the methodology presented in [3] and [4]. These results suggest that the asymmetry associated with the network contributes approximately by 65% to the resultant voltage unbalance levels at the critical busbars (S2, S4 and S6 - S9) indicating that it can be identified as the primary source of the voltage unbalance problem. The unbalanced loads are seen to play only a secondary role.

The nodal level contributions made by the individual loads and the lines to the resultant voltage unbalance levels are presented using a stacked bar graph in Fig. 12. It can be seen from these results that among all the individual sources which give rise to voltage unbalance, lines F and I are the leading contributors of the overall voltage unbalance problem. In addition, line A, and the loads supplied at busbars S2 and S4 contribute significantly to the problem supporting the two leading contributors (lines F and I) to aggravate the resultant emission levels. Lines D and L, and the load at busbar S7 are seen to make negative contributions. It is worthwhile noting that the load supplied by busbar S8 of which the emission level

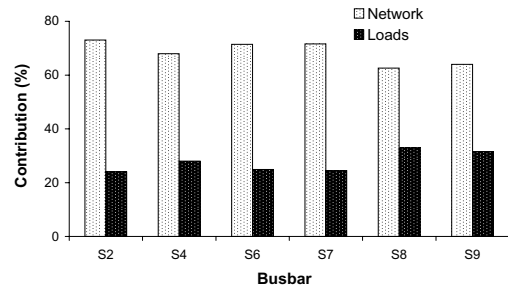

Fig. 11. Nodal contribution made individually by the network and the loads to the resultant voltage unbalance levels

on its own was significant is seen to make only a negligible contribution to the overall problem.

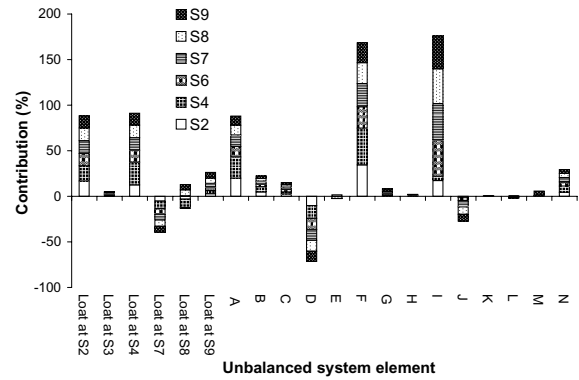

Fig. 12. Nodal contribution of individual unbalanced elements (lines and loads) to the resultant voltage unbalance levels

The above results (in Fig. 11 and Fig. 12) can also be explained employing the emission vectors of individual elements presented in Fig. 5 and Fig. 9 (ie. by superimposing them). The impact of the load at busbar S8 is seen to be counter balanced by the emissions of lines D and J. Further, the emissions of lines I, F and A, and the loads at busbars S2 and S4 which lie in close proximity are seen to drive the resultant voltage unbalance levels in general.

VI. MITIGATION OPTIONS FOR VOLTAGE UNBALANCE PROBLEM

The results in Fig. 12 or the individual emission vectors presented in Fig. 5 and Fig. 9 can be used to identify the optimum voltage unbalance mitigation options for the study system. The best option involving a single line is the transposition of line I which brings the existing highest voltage unbalance level (1.9% at busbar S9) down to 1.2% . Transposition of both lines F and I is the best option involving two lines for an increased degree of correction. This is seen to be capable of maintaining the voltage unbalance levels (0.75% at busbar S9) below the code requirements. Fig. 13 and Fig. 14 illustrates the nodal residual voltage unbalance levels and the nodal degree of correction respectively arising as a result of each of the proposed mitigation approaches.

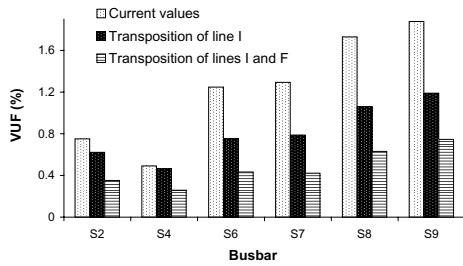

Fig. 13. Nodal residual voltage unbalance levels arising due to proposed mitigation options, in comparison to the current voltage unbalance levels

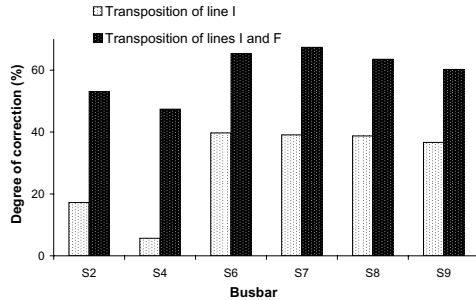

Fig. 14. Nodal degree of correction arising due to proposed mitigation options

VII. CONCLUSIONS

The work presented in this paper covers a deterministic study, employing a study system, with a view to understand the level of contributions made by untransposed sub-transmission lines and unbalanced loads operating in interconnected environments in relation to the problem of voltage unbalance. The methodology described allows systematic identification of potential mitigation options. Following major conclusions can be drawn from the study:

- A complete picture of the role played by asymmetrical transmission lines in relation to the problem of voltage unbalance can be generally established using the negative sequence voltage emission vectors which can be derived by observing the associated impedance Z_{-+} (magnitude and phase angle), loading level ($|I_{+}|$) and location of individual lines.
- Similarly, the overall voltage unbalance behaviour of individual loads is also possible to establish by examining the associated degree of asymmetry (μ_P), order of power distribution across the three-phases and location of individual loads.
- On the whole, a theoretical basis facilitating identification of dominant sources of voltage unbalance and intelligent selection of mitigation options can be established.

REFERENCES

- [1] System Standards, National Electricity Code Australia, Version 1.0 - Amendment 9.0, S5.1a.7, October 2004.
- [2] Electricity Distribution Code, Victoria, January 2002.
- [3] Prabodha Paranavithana, Sarath Perera and Danny Sutanto, "Analysis of System Asymmetry of Interconnected 66kV Sub-transmission Systems in relation to Voltage Unbalance", *IEEE PES PowerAfrica 2007 Conference and Exposition*, Paper 35, Johannesburg-South Africa, 16-20 July 2007.

- [4] P. Paranavithana, S. Perera, D. Sutanto, and R. Koch "Analysis of an Interconnected 66kV Sub-transmission Systems in relation to Voltage Unbalance - A Case Study", *IEEE Trans. on Power Delivery*, submitted for review.
- [5] Prabodha Paranavithana, Sarath Perera and Danny Sutanto, "Impact of Untransposed 66kV Sub-transmission Lines on Voltage Unbalance", *Australasian Universities Power Engineering Conference, AUPEC*, Paper 28, Melbourne-Australia, Dec. 2006.
- [6] "Electromagnetic Compatibility (EMC) - Limits - Assessment of Emission Limits for the Connection of Unbalanced Installations to MV, HV and EHV Power Systems", IEC Technical Report 61000-3-13, Ed. 1, 2008.

Prabodha Paranavithana received the B.Sc.(Eng) (Hons.) degree in electrical power engineering from the University of Moratuwa, Sri Lanka.

Currently she is pursuing studies towards the Ph.D. degree at the University of Wollongong, Australia. Her research interests are in power quality and power system analysis.



Sarath Perera received the B.Sc.(Eng) degree in electrical power engineering from the University of Moratuwa, Sri Lanka, a M.Eng.Sc. degree from the University of New South Wales, Australia, and the Ph.D. degree from the University of Wollongong, Australia.

He has been a lecturer at the University of Moratuwa, Sri Lanka. Currently he is an Associate Professor with the University of Wollongong. He is the Technical Director of the Integral Energy Power Quality and Reliability Centre at the University of



Wollongong.

Danny Sutanto received the B.Eng. (Hons.) and Ph.D. degrees in electrical power engineering from the University of Western Australia, Australia.

He is presently the Professor of Power Engineering at the University of Wollongong, Australia. His research interests include power system planning, analysis and harmonics, FACTS and Battery Energy Storage systems. He was the IEEE PES Region 10 (Asia - Pacific) Regional Representative in 2002-2004.



Robert Koch received the B.Eng. and M.Eng. degrees in electrical power engineering from the University of Stellenbosch, South Africa.

He is a Corporate Specialist with Eskom Holdings Limited, South Africa and Convener of IEC 77A/WG8 - the working group responsible for publishing IEC/TR 61000-3-13. He is an active participant in Cigre working groups - and was the document coordinator for the Cigre report on which IEC 61000-3-13 was based. He is currently the Convener of Advisory Group C4.1 (Power Quality), of Study Committee C4 (System Technical Performance).

