

1-1-2012

Performance of CFRP Wrapped Square Reinforced Concrete Columns Subjected to Eccentric Loading

Ida Bagus Rai Widiarsa
University of Wollongong, ibrw943@uow.edu.au

Muhammad N. S Hadi
University of Wollongong, mhadi@uow.edu.au

Follow this and additional works at: <https://ro.uow.edu.au/engpapers>



Part of the [Engineering Commons](#)

<https://ro.uow.edu.au/engpapers/4415>

Recommended Citation

Widiarsa, Ida Bagus Rai and Hadi, Muhammad N. S: Performance of CFRP Wrapped Square Reinforced Concrete Columns Subjected to Eccentric Loading 2012, 375-386.
<https://ro.uow.edu.au/engpapers/4415>

The 2nd International Conference on Rehabilitation and Maintenance in Civil Engineering

Performance of CFRP Wrapped Square Reinforced Concrete Columns Subjected to Eccentric Loading

Ida Bagus Rai Widiarsa^{a*} and Muhammad N.S. Hadi^b

^a*Department of Civil Engineering, University of Udayana, Bali, Indonesia*

^b*School of Civil, Mining and Environmental Engineering, University of Wollongong, Wollongong, NSW, Australia*

Abstract

Strengthening concrete columns with fibre-reinforced polymers (FRP) has been studied extensively, but the majority of published studies have focused on circular columns. Most concrete columns in the field have square or rectangular cross sections and resist eccentric loading as well. The objective of this study is to investigate the performance of square reinforced concrete (RC) columns wrapped with carbon FRP subjected to eccentric loading. The influence of two parameters was studied including the number of FRP layers and the magnitude of eccentricity. Compression testing was conducted on twelve short square RC columns wrapped with CFRP composites. The columns had a dimension of 200 mm x 200 mm x 800 mm and a round corner with a radius of 34 mm. The results of the study demonstrated that wrapping the square RC columns under eccentric loading with CFRP enhanced their performance by providing higher load carrying capacity and ductility compared to unwrapped RC columns.

Keywords: square RC column; CFRP; eccentric loading; ductility.

1. Introduction

Advanced composite materials are generally used in the industrial fields like aerospace, marine and automotive industries due to their excellent engineering properties such as high strength, high stiffness, high durability, low density, high fatigue endurance, low thermal coefficient, corrosion resistance and good strength-to-weight ratio (Pendhari et al., 2008). Due to many problems associated with the deterioration of the civil infrastructure, civil engineers and the construction industry have realized for many years the use of potential benefits of the composites as materials for strengthening or retrofitting of the structures.

The use of fibre reinforced polymer (FRP) composites that are externally applied for strengthening reinforced concrete structures such as beams, slabs and columns has been done experimentally by many researchers and has been applied in construction. A column is one of the essential elements in civil engineering structures that transmits loads from the upper levels to the lower levels and then to the soil through the

* Corresponding author.

E-mail address: ibrw943@uowmail.edu.au

foundations. During their service life, columns can undergo deterioration caused by environmental effects or fatigue of its constituent materials thus leading to the reduction of the column's strength. Instead of demolishing and then rebuilding the columns, retrofitting or strengthening can be taken as an alternative way to maintain the columns.

Retrofitting or strengthening reinforced concrete columns by using FRP composites is preferred than by using other materials like steel due to its high strength-to-weight ratio and high corrosion resistance. Several investigations on FRP retrofitted or strengthened concrete columns have been undertaken for many years. Most of these studies investigated the behaviour of columns under concentric loads (Kumutha et al. 2007; Wang and Wu 2008) and only a few studies investigated columns under eccentric loads. Consideration of applying eccentric loads was undertaken by researchers due to the reality that most columns in the field resist a combination of axial load and bending moment.

The application of eccentric loads on FRP strengthened concrete columns have been done by a few researchers. Other than the magnitude of eccentricities, the shape of column cross section is an important factor that influences the confining behaviour of the FRP strengthened concrete columns. Some investigations on FRP strengthened concrete columns under eccentric loads have been done by researchers and mostly concerned on columns having a circular cross section (Li and Hadi 2003; Hadi 2006; Hadi 2007; Bisby and Ranger 2010). Only a few investigations have studied concrete columns with square or rectangular cross sections (Parvin and Wang 2001; Maaddawy 2009). Moreover, most concrete columns in the field have square or rectangular cross sections rather than a circular one and may resist eccentric loads as well. Therefore, research on FRP strengthened square or rectangular concrete columns under eccentric loads is still required to be conducted for the purpose of understanding their behaviour and performance.

This study investigates the performance of square reinforced concrete (RC) columns wrapped with carbon fibre reinforced polymer (CFRP) composites under eccentric compression loading. The performance of the columns was evaluated by analyzing their load carrying capacity and ductility.

2. Experimental Program

The experimental program of this study was conducted at the laboratories of the School of Civil, Mining and Environmental Engineering at the University of Wollongong, Australia.

2.1. Column Specimens

Twelve short high strength reinforced concrete columns were cast and tested in this study. Each column had a square cross section with a dimension of 200 mm x 200 mm x 800 mm. Short columns were designed to avoid the formation of secondary moments due to the slenderness effect. Moreover, the dimensions were chosen to be adaptable with the condition and capacity of the available testing machine in the laboratory. The four corners of the columns were rounded for avoiding premature failure and preparing

sufficient effect of confinement of the columns (Wang and Wu 2008; Mirmiran et al. 1998). For providing a consistent concrete cover of 20 mm to the steel, a corner radius of 34 mm was then applied to the specimens. The longitudinal and transversal reinforcement of columns were designed in accordance with the Australian Standard for Concrete Structure AS3600-2009. All columns were designed inadequately as their internal steel reinforcement ratio was about the lowest ratio of that specified by the standard. The purpose of this design was to produce the condition of the column as an old column that has deteriorated and needs to be strengthened. In addition, the shear reinforcement provided was also at the minimum shear reinforcement required by the standard ($A_{sv,min}$). Therefore, the columns had four N12 (12 mm diameter deformed bars with nominal tensile strength of 500 MPa) as longitudinal steel reinforcement and R8 (8 mm diameter plain bars with nominal tensile strength of 250 MPa) spaced at 100 mm as transverse steel reinforcement (ties).

2.2. Columns Configuration

The column specimens were divided into four groups: three columns unwrapped, three columns wrapped with one-layer of CFRP, three columns wrapped with three-layers of CFRP and three columns wrapped with two-layers of horizontal (circumferential) CFRP and one-layer of vertical (along specimen axis) strap. For the fourth group, columns were wrapped with two-layers of CFRP after the application of one-layer of vertical CFRP strap. The columns were labelled as shown in the first column of Table 1.

Table 1. Configuration of test specimens

Test specimens	Internal reinforcement		Number of CFRP layers	Type of loading
	Longitudinal	Transversal		
0C0 0C25 0C50	4N12	R8@100 mm	None	Axial, concentric Axial, $e = 25$ mm Axial, $e = 50$ mm
1HC0 1HC25 1HC50	4N12	R8@100 mm	One-layer	Axial, concentric Axial, $e = 25$ mm Axial, $e = 50$ mm
3HC0 3HC25 3HC50	4N12	R8@100 mm	Three-layers	Axial, concentric Axial, $e = 25$ mm Axial, $e = 50$ mm
1V2HC0 1V2HC25 1V2HC50	4N12	R8@100 mm	Two-layers with one-layer strap	Axial, concentric Axial, $e = 25$ mm Axial, $e = 50$ mm

Note: e = eccentricity

2.3. Material Properties

All column specimens used in this study were constructed with ready-mix high strength concrete supplied by a local supplier. All specimens were cast from one batch of concrete. The compressive strength of the concrete was determined by conducting tests on 100 mm diameter cylinders. The average 28-day compressive strength of concrete was 79.5 MPa. Column specimens were placed under wet hessian rugs and

covered with plastic sheets to maintain their moisture conditions. Two types of steel reinforcements were used, deformed steel bars N12 for longitudinal reinforcement and plain steel bars R8 for transversal reinforcement (ties). Tests were conducted to determine the tensile strength of the reinforcing steel. The tensile strength of 564 MPa and 516 MPa were obtained for N12 and R8 reinforcing bars, respectively. The fibre composite used for wrapping the column specimens was carbon fibre reinforced polymer (CFRP). The carbon fibre available was in the form of rolls which was 100 m in length and 75 mm in width. Tensile test was also conducted to determine the tensile strength of CFRP according to ASTM D 3039/D 3039M – 08 [14]. Table 2 shows the average results of testing CFRP coupons. Three coupons were tested for each number of layers.

2.4. Test Setup

Twelve columns labelled as in Table 1 were tested under compression loading up to failure. The Denison 500 tonne compression testing machine was used to test all the columns. Levelling the column ends was done first in order to obtain a uniform distributed load applied to the entire face. High strength plaster was used for this purpose. For applying the eccentric loading on the column, a loading mechanism as shown in Figure 1 was designed and a new set of loading heads made with high strength steel plate as shown in Figure 2 was manufactured. The loading heads were attached at both ends of the column. The loading head consists of two parts: a 25 mm thick steel plate, called bottom plate which has a ball joint, and a square 50 mm thick steel plate, called adaptor plate. The bottom plate transfers the load generated by the machine to the adaptor plate through the ball joint which has a designed eccentricity with the column. Then the adaptor plate exerts the load to the columns. For applying the concentric loading, only adaptor plates were used in the test.

Table 2. Properties of CFRP composites

	1-layer	3-layers	2-long. layers and 1-transversal layer	1-long. layer and 2-transversal layers
Average width (mm)	18.6	19.5	18.2	17.7
Average thickness (mm)	0.79	1.67	1.45	1.42
Average gauge length (mm)	141.7	139.7	139.5	139.6
Maximum load (kN)	12.514	37.335	20.864	11.226
Maximum stress (MPa)	854	1,148	793	449
Strain at maximum stress	0.0183	0.0203	0.0172	0.0192
Modulus of elasticity (GPa)	46.507	56.690	46.002	23.329

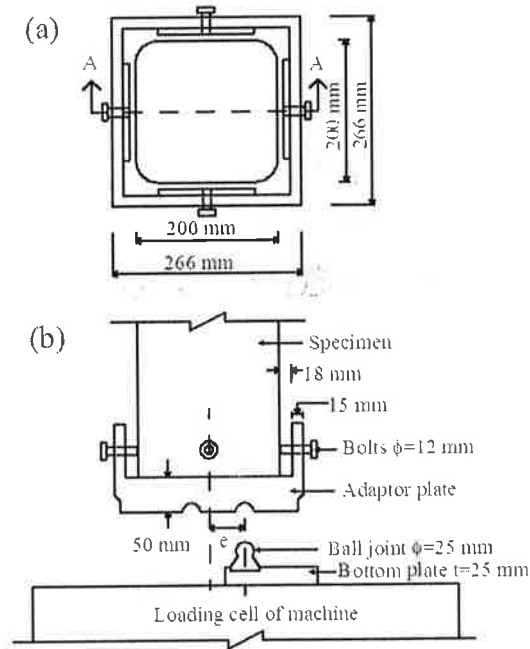

Figure 1. Developed eccentric loading mechanism. (a) Plan view; (b) Section A-A

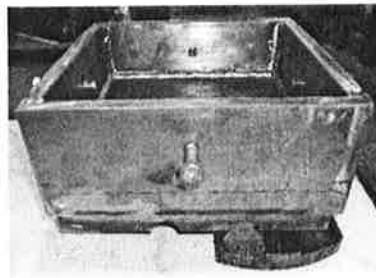

Figure 2. Manufactured loading head

The compression testing of the column used two different monitoring systems to measure the deflection of the column specimens. For the concentrically loaded columns, one LVDT was connected directly to the testing machine to measure the axial displacement of the column during the test. Data read from this LVDT was recorded at the same time with load data recorded by the testing machine. A second LVDT which was a laser LVDT was also used in addition to the first one for eccentrically loaded columns to measure the lateral deflection of the column. The second LVDT was placed horizontally near the mid-height of the specimen. When the specimen and the instrumentation were placed in position and initial calibration was done, the compression testing was then started. The specimen was tested under displacement control with a loading rate of 0.5 mm/min and the end point position was set at 50 mm. A photo of a typical compression testing is shown in Figure 3.

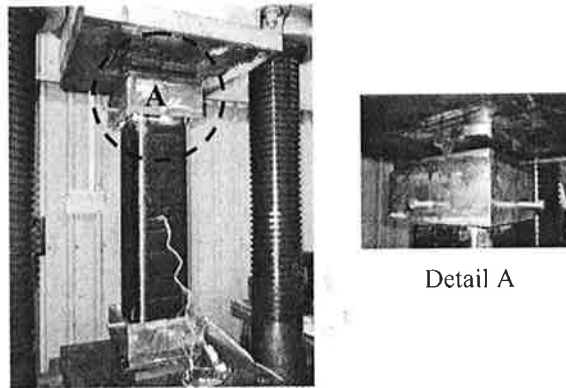

Figure 3. A typical setup of compression testing

3. Experimental Results and Discussion

3.1. Failure Modes of Columns

The failure of the column was monitored visually along with the testing. Different modes of failure were observed between unwrapped columns and wrapped columns. For columns without CFRP wrapping, the failure was generally marked with sudden peeling of concrete cover, followed by rupture of the ties and buckling of the longitudinal reinforcement. The failure did not occur exactly at the mid height but still in the test region. Meanwhile, the failure of the columns wrapping with CFRP was initiated by the appearance of FRP ripple at some places on the column sides followed by a snapping sound when the load approached the maximum load. At the maximum load, the first rupture of CFRP resulted in decreasing of the load. The columns continued supporting the load until the rupture of the other CFRP while experiencing a larger displacement. The rupture of CFRP and debonding between the CFRP layer and the concrete revealed the concrete expansion at the place where the CFRP failed. The CFRP rupture occurred typically at or near the corner of the columns due to the stress concentration in these locations. Buckling of longitudinal reinforcement and crushing of concrete in compression were also observed.

3.2. Behaviour of Columns

The ultimate load and the corresponding axial and lateral displacements were recorded during the compression testing and the results are summarized in Table 3. The ductility of the columns was analyzed as well to describe the performance of the columns. Two methods were used in the analysis to determine the ductility of the specimens. The first method used the ratio of axial displacement at ultimate load to the axial displacement at yield load. The second method used the ratio of area under the load-axial displacement curve up to the ultimate displacement to the area under the curve up to the yield load. The ultimate displacement was assumed to be the displacement at 85% of the maximum load [15].

The load-axial displacement curves for the columns loaded concentrically are shown in Figure 4. It is shown clearly that the columns performed a similar behaviour before reaching the maximum load. The biggest maximum load and axial displacement among the four columns was achieved by wrapping the column with three-layers of CFRP. The maximum load did not increase significantly with the CFRP wrapping. However, wrapping columns with CFRP enhanced the performance of the columns by increasing their displacement at failure. The increase of maximum load of 1%, 8.4% and 10.4% relative to unwrapped column was achieved for Columns 1HC0, 1V2HC0 and 3HC0, respectively.

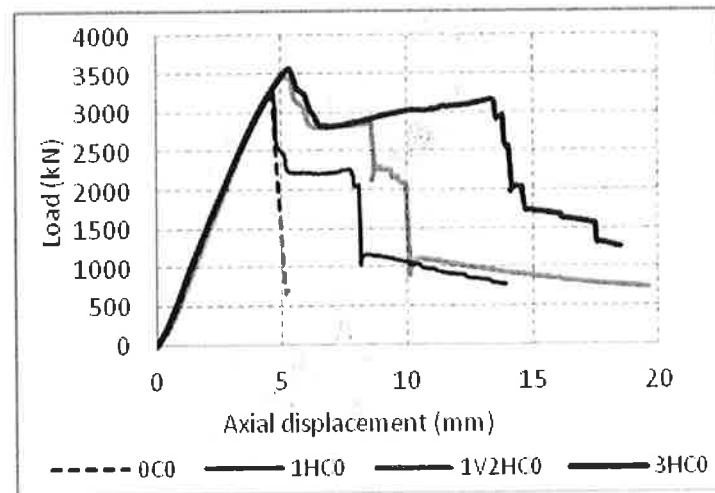

Figure 4. Load-displacement curves for columns tested under concentric loading

Figure 5 shows the axial and lateral displacement versus the applied load curves for columns tested under 25 mm eccentric loading. A similar behaviour was also observed on these columns before reaching the maximum load. Column 1V2HC25 reached the biggest maximum load and axial displacement among the four columns. The 17.7% and 16.4% increase of maximum load was achieved for Columns 1V2HC25 and 3HC25, respectively. However, Column 3HC25 showed a better performance than Column 1V2HC25. Column 1HC25 also had a better performance than the unwrapped column (Column 0C25) although a small increase of maximum load was achieved. Columns 1HC25 had only 6.5% higher maximum load than Column 0C25. CFRP rupture occurred on all wrapped columns before failure.

Table 3. Results of compression testing of column specimens

Test specimen	Ultimate load (kN)	Displacement at ultimate load (mm)		Axial displacement (mm)			Ductility	
		Axial	Lateral	At yield	At 85% ult. load	Maximum	Method 1*	Method 2*
0C0	3248	4.581	-	3.207	4.706	5.199	1.47	2.09
1HC0	3279	4.525	-	3.201	4.746	13.880	1.48	2.18
3HC0	3585	5.290	-	3.626	13.465	18.505	3.71	7.16
1V2HC0	3522	4.997	-	3.574	8.565	19.567	2.40	4.39
0C25	1950	3.912	1.869	2.931	4.121	6.245	1.41	1.87
1HC25	2076	4.452	2.253	3.105	5.067	9.898	1.63	2.68
3HC25	2269	4.476	2.113	3.176	11.166	14.948	3.52	7.45
1V2HC25	2296	4.763	2.443	3.192	8.296	15.944	2.60	5.17
0C50	1336	3.862	2.645	2.930	4.005	4.662	1.37	1.90
1HC50	1433	4.050	2.315	3.019	4.984	13.198	1.65	2.84
3HC50	1534	3.989	3.193	2.885	6.641	13.089	2.30	4.66
1V2HC50	1533	3.987	2.520	2.882	9.217	14.547	3.20	7.06

*Refer to Section 3.2 for definition of the methods.

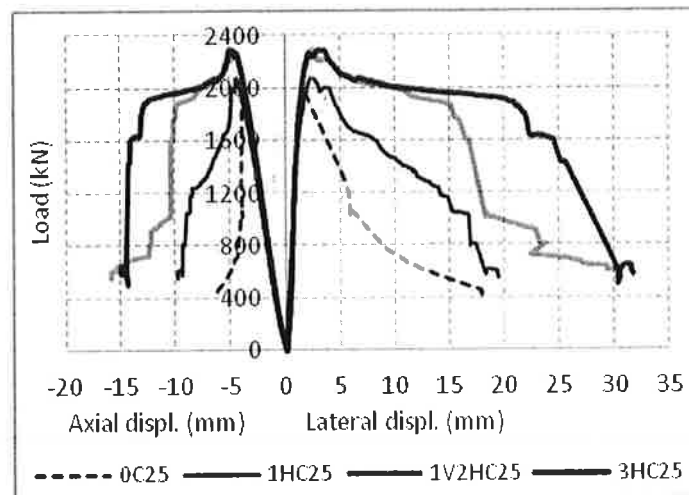

Figure 5. Load-displacement curves for columns tested under 25 mm eccentricity

The applied load versus the axial and lateral displacements curves for columns tested under 50 mm eccentric loading are shown in Figure 6. Failure in compression was also observed in all columns with cracks in the tension face near the mid height of the columns. FRP rupture occurred and followed by an increase in displacement after the maximum load was reached. Columns 1V2HC50 and 3HC50 had similar increase of maximum load of 14.8%, however Column 1V2HC50 had a better performance than Column 3HC50. Column 1HC50 had 7.3% increment in maximum load and a better performance than the unwrapped column (Column 0C50).

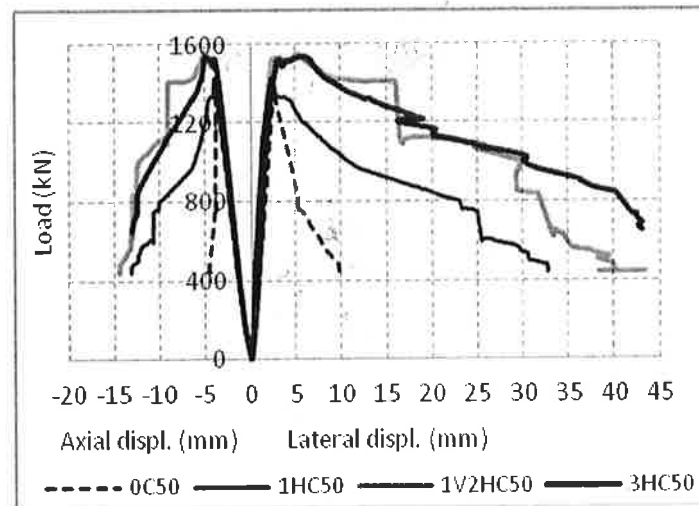

Figure 6. Load-displacement curves for columns tested under 50 mm eccentricity

From compression testing the column specimens, it was observed that wrapping columns with CFRP increased the maximum load of the columns. A more important advantage was achieved that was all wrapped columns showed a better performance than the unwrapped columns.

The performance of column can be indicated with ductility which was reported in Table 3. It can be seen from the load-displacement curves of the columns that the displacement increased with the increasing the load until approaching the maximum load. Then, for unwrapped columns failure of columns occurred which was initiated by a peeling of concrete cover and followed by a sudden drop of load. For wrapped columns, FRP rupture occurred when the maximum load was reached and followed by the decrease of load and a sharp increase of displacement. At this stage, the effect of confinement was active to control the behaviour of the columns. Following FRP rupture the applied load was decreased, and the displacement increased until the column failed.

3.3. Influence of Eccentricity

In order to describe the influence of the eccentricity on the behaviour of the columns, load-axial displacement curves of the columns were plotted which were grouped according to the number of CFRP layers. Figure 7 shows the behaviour of the unwrapped columns, Figure 8 shows the behaviour of the columns wrapped with one-layer of CFRP, Figure 9 shows the behaviour of the columns wrapped with three-layers of CFRP and Figure 10 shows the behaviour of the columns wrapped with two-layers of CFRP and one-layer of vertical strap.

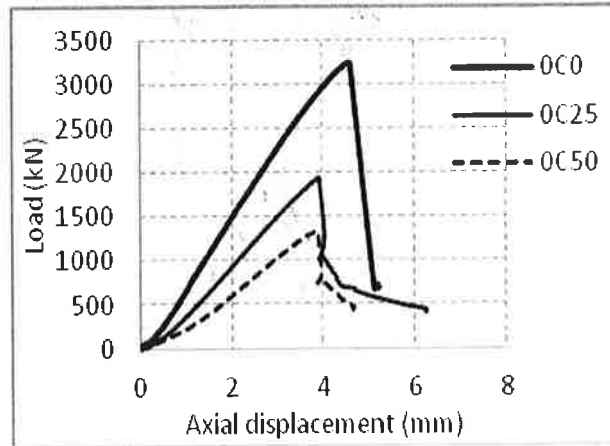

Figure 7. Load-displacement curves of columns 0C0, 0C25 and 0C50

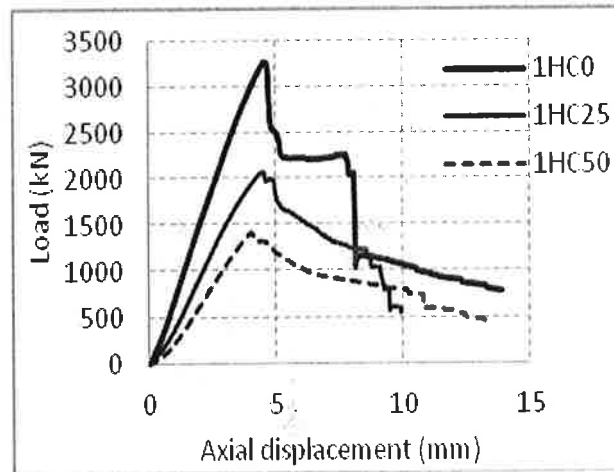

Figure 8. Load-displacement curves of columns 1HC0, 1HC25 and 1HC50

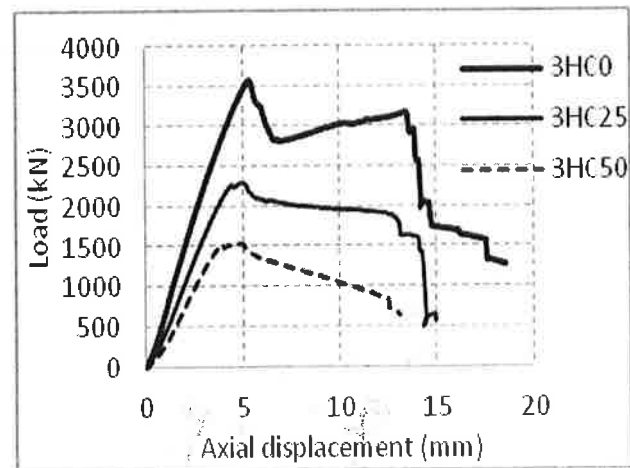

Figure 9. Load-displacement curves of columns 3HC0, 3HC25 and 3HC50

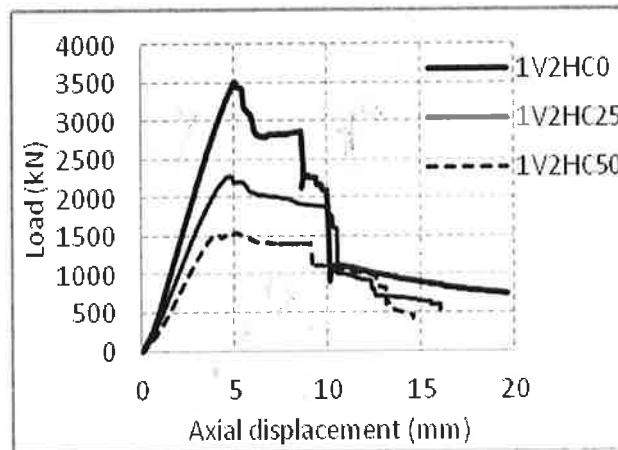

Figure 10. Load-displacement curves of columns 1V2HC0, 1V2HC25 and 1V2HC50

It can clearly be seen that the eccentricity of loading reduces the load carrying capacity and performance of the columns. Such a phenomenon is also evident in Figure 11 which presents the change of the load carrying capacity of the columns with the eccentricity. It can be observed that columns wrapped with three-layers of CFRP (Column 3HC) had similar performance to column wrapped with two-layers of CFRP and one-layer of vertical strap (Column 1V2HC). Improvement in load carrying capacity was only obtained by the column wrapped with one-layer of CFRP when it resisted an eccentric loading.

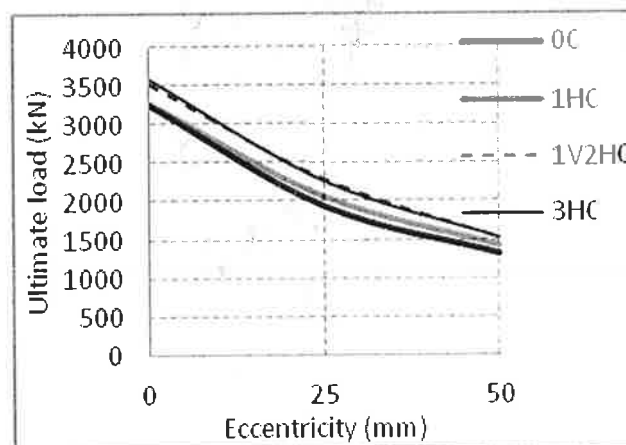

Figure 11. Influence of eccentricity on load carrying capacity of columns

4. Conclusions

Based on the analysis of the experimental results obtained in this study, some important findings can be drawn. The compressive loading test results of the columns indicate that wrapping columns with CFRP increased the load carrying capacity of the columns. An important advantage was achieved that CFRP wrapping enhanced the performance of the columns by postponing the rupture of the concrete and reinforcement. It increased the column ductility. Increasing the number of the CFRP layers resulted in increasing the load and the performance of the columns. It was

revealed that in columns with a large eccentricity, which means with a large bending moment, the presence of CFRP straps produced higher load and ductility than that in columns wrapped horizontally with similar number of CFRP layers. It was also obtained from this study that the eccentricity of loading reduces the load carrying capacity and performance of the columns. Finally, it was proven that wrapping square RC columns with CFRP enhanced the performance of the columns. Wrapping with a minimum of three-layers would be suggested to achieve significant results.

Acknowledgement

The authors acknowledge the financial support of the University of Wollongong for conducting the research. The first author also acknowledges the financial support from the Indonesian Government for sponsoring his studies at the University of Wollongong.

References

- American Society for Testings and Materials, Standard Test Method for Tensile Properties of Polymer Matrix Composite Materials (ASTM D 3039/D 3039M – 08). (2008).
- Bisby L and Ranger M(2010). Axial-Flexural Interaction In Circular FRP-Confined Reinforced Concrete Columns. *Construction and Building Materials*, Vol. 24, pp 1672-1681.
- GangaRao et al. (2007). *Reinforced Concrete Design with FRP Composites*. CRC Press, London.
- Hadi MNS (2006). Behaviour of FRP Wrapped Normal Strength Concrete Columns under Eccentric Loading. *Composite Structures*, Vol. 72, pp 503–511.
- Hadi MNS (2006). Comparative Study of Eccentrically Loaded FRP Wrapped Columns. *Composite Structures*, Vol. 74, pp 127–135.
- Hadi MNS (2007). Behaviour of FRP Strengthened Concrete Columns under Eccentric Compression Loading. *Composite Structures*, Vol. 77, pp 92–96.
- Hadi MNS (2007). The Behaviour of FRP Wrapped HSC Columns under Different Eccentric Loads. *Composite Structures*, Vol. 78, pp 560–566.
- Kumutha et al. (2007). Behaviour of Reinforced Concrete Rectangular Columns Strengthened Using GFRP. *Cement & Concrete Composites*, Vol. 29, pp 609-615.
- Li J and Hadi MNS(2003). Behaviour of Externally Confined High Strength Concrete Columns under Eccentric Loading. *Composite Structures*, Vol. 62, pp 145-153.
- MaaddawyTE (2009). Strengthening of Eccentrically Loaded Reinforced Concrete Columns with Fiber-Reinforced Polymer Wrapping System: Experimental Investigation and Analytical Modeling. *Journal of Composites for Construction*, January/February, pp 13-24.
- Mirmiran et al. (1998). Effect of Column Parameters on FRP-Confined Concrete. *Journal of Composite for Construction*, November, pp 175-185.
- Parvin A and Wang W (2001). Behavior of FRP Jacketed Concrete Columns under Eccentric Loading. *Journal of Composites for Construction*, August, pp 146-152.
- Pendhari et al. (2008). Application of Polymer Composites in Civil Construction: A General Review. *Composite Structures*, Vol. 84, pp 114-124.
- Standards Australia, *Concrete Structures*, Australian Standard (AS3600-2009).(2009). Sydney.
- Wang LM and Wu YF(2008). Effect of Corner Radius on the Performance of CFRP-Confined Square Concrete Columns: Test. *Engineering Structures*, Vol. 30, pp 493-505.