

1-1-2005

Status of outburst research at the University of Wollongong

Najdat I. Aziz
University of Wollongong, naj@uow.edu.au

F. Sereshki
University of Wollongong

Dieter Bruggemann
University of Wollongong, db889@uow.edu.au

Follow this and additional works at: <https://ro.uow.edu.au/engpapers>



Part of the [Engineering Commons](#)

<https://ro.uow.edu.au/engpapers/2971>

Recommended Citation

Aziz, Najdat I.; Sereshki, F.; and Bruggemann, Dieter: Status of outburst research at the University of Wollongong 2005, 283-289.
<https://ro.uow.edu.au/engpapers/2971>

2005

Status of Outburst Research at the University of Wollongong

N. Aziz

University of Wollongong, naj@uow.edu.au

F. Sereshki

University of Wollongong

D. Bruggemann

University of Wollongong

Publication Details

This conference paper was originally published as Aziz, N, Sereshki, F and Bruggemann, D, Status of Outburst Research at the University of Wollongong, in Aziz, N (ed), Coal 2005: Coal Operators' Conference, University of Wollongong & the Australasian Institute of Mining and Metallurgy, 2005, 283-290.

Status of Outburst Research at the University of Wollongong

N Aziz¹, F Sereshki¹ and D Bruggemann¹

ABSTRACT

There has been an ongoing research on coal and gas outburst for the past two decades at the School of Civil, Mining and Environmental Engineering, University of Wollongong. Research study began with a humble beginning, initially conducting basic laboratory studies on the coal and gas properties, progressing into the determination of gas content of coal by sorption technique and the effect of gas pressures on coal strength. The present laboratory facilities and research interests are extended to include the study of coal permeability and shrinkage properties and their effect of gas drainage characteristics with respect to gas type, and pressures. All the changes are examined with respect to changing in-site geological conditions of the coal deposit investigated. The aim is to provide a long-term support to industry in establishing a data bank for Australian coal deposit characteristics and properties.

INTRODUCTION

For more than two decades, there has been a continuous program of research at the School of Civil, Mining and Environmental Engineering, University of Wollongong. Much of the early research studies were carried out in collaboration with the late Dr Ripu Lama. Initially the main study was related to sorption technique for determining gravimetrically the gas content of coal, and the extended later to volumetric method. Other studies undertaken included the modelling of gas sorption in coal (Nguyen, 1988). The next phase of the research involved the development of a multi function outburst rig (MFORR) for outburst research. The MFORR was initially used to study the effect of gas environment on the strength properties of coal including:

1. The effect of gas pressure on coal tensile strength, using the well known Brazilian method of indirect tensile testing of cylindrical core samples in different gas pressure confinements.
2. The effect of gas pressure gradient on coal load bearing capacity.
3. Study of the strength of coal by examining the particle size distribution of drill cuttings under different gas environments. A high precision drill of controlled speed up to ten different levels was used to study the changes in particle size distribution with respect to increased gas type, gas pressure. The changes in coal strength properties were also compared with drilling of coal in air (Aziz, Hutton and Indraratna, 1996).

Concurrent with the above, an extensive study of various coal seams gas content was conducted using an in-house built adsorption and desorption apparatus. The local coal mining companies with matching grants being provided by the University of Wollongong, though small, mostly provided financial support. Recent research emphasis has since been shifted towards the establishment of a long-term database for coal properties including coal permeability, coal shrinkage and coal petrology, for an effective outburst management.

EQUIPMENT DESCRIPTION

Adsorption and desorption apparatus

This equipment has been the focus of outburst program research for the past two decades. Initially it was constructed to determine

1. School of Civil, Mining and Environmental Engineering, University of Wollongong, Wollongong NSW 2500.

indirectly, and gravimetrically the gas content of coal at different gas pressures, nowadays it is also used for coal sample preconditioning, prior to permeability, coal shrinkage and coal strength tests. The apparatus (Figure 1) consists of number cylindrical pressure vessels, known as pressure 'bombs'. Coal samples are sealed in gas bombs and pressurised to a saturation level at various predetermined pressures up to 5 MPa. The sample containers are immersed in a water bath, but are isolated from the water bath by copper sleeves to keep them dry. A thermostatically controlled water bath (with a stirrer) allows the coal samples to be kept at the desired temperatures. Further details of equipment construction, operation and gas content calculations at various pressure levels are described elsewhere (Aziz and Ming-Li, 1999).

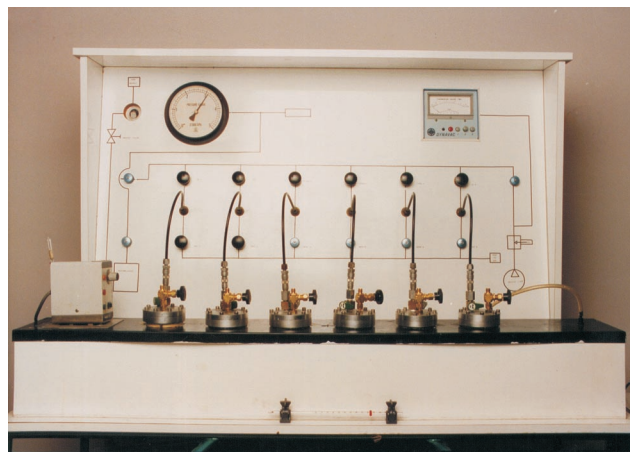

FIG 1 - High pressure sorption/desorption apparatus.

Coal shrinkage test

Figure 2, is basically the pressure vessel (bomb) component of adsorption and desorption equipment used previously for indirect method of determining the gas content of coal. The only modification introduces to the bomb is the addition of pressure transducer on the lid of each bomb to monitor the bombs inlet gas pressures. Coal samples are sealed in gas bombs and pressurised to a saturation level at 3 MPa. It is then immersed in a water bath to maintain it at a constant temperature of around 25°.

Before, the coal samples are placed in the bombs; four strain gauges are mounted on each sample surface to monitor axial and radial strains on coal size due to gas sorption. The mounting of the strain gauges is carried out in accordance to International Society of Rock Mechanics (ISRM) standard. A data taker 'model DT50' is used to retrieve information from the bomb which is then connected to a PC for data analysing.

Multi function outburst research rig (MFORR)

MFORR comprises a number of components, which can be utilised on a variety of research studies, initially built for the study of the evaluation of changing coal strength properties with respect to changing gas environment of the coal sample tested. At present the rig is used mainly for coal permeability studies. The integrated components of the MFORR include:

1. main frame,
2. gas pressure chamber – also used for coal permeability studies,
3. drilling system,
4. drill support frame,
5. drill cutting collection system,
6. universal socket for vertical load application,
7. flow metres (see Figure 4),
8. data acquisition system, and
9. various components for coal strength properties tests.

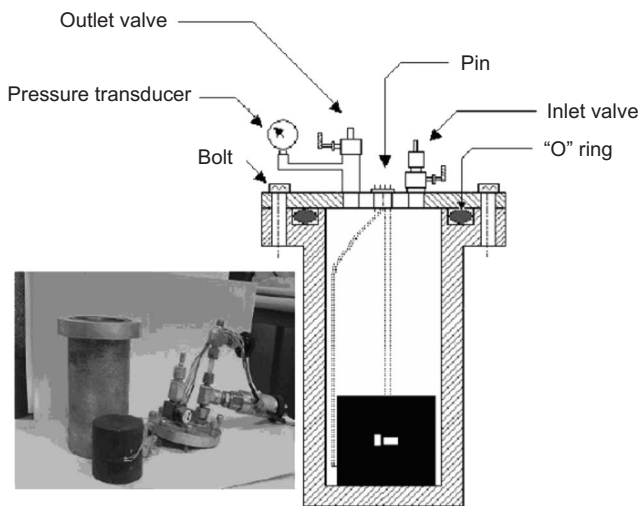

FIG 2 - Coal shrinkage test vessel (bomb).

Figure 3 shows a general view of the MFORR. The components of the MFORR are interchangeable with respect to the type of tests undertaken. The main frame comprised a sturdy steel structure, which houses the gas chamber, a drilling frame which carried the drill, the universal thrust connector and the drill motor speed controller. The gas pressure chamber is a rectangular prism of cast iron with removable front and back viewing plates. The dimensions were 110 mm × 110 mm × 140 mm.



FIG 3 - A general view of MFORR.

When used as a precision drill, the pressure drill rig (PDR) consists of drill frame, drill motor with drill bit, drilling thrust system and drilling cutting collection device. A multi-pulley system enabled constant thrust to be applied on the drill bit. The thrust is generated by a suspended steel cylindrical bucket filled with lead shot. The drill cuttings are collected in a specially designed catcher, fitted with a disc of filter, and connected to a suction pump. The collected drill cuttings are subsequently weighed and analysed for particle size characterisation. A Malvern particle size analyser is used to conduct particle size analysis of drill cuttings. The particle size analyser is capable to classifying particle sizes between 1 mm and 0.5 µm.

MFORR for permeability test

When MFORR is used for coal permeability, the precision drill section and drill cutting collection system are disengaged and the gas pressure chamber is reassembled to cater for the needs of the permeability tests. Figure 4 shows the schematic diagram of the test rig (Aziz, Porter and Sereshki, 2004). The high-pressure gas chamber is connected to a set of flow metres for monitoring gas flow rates. To conduct the test, the samples are cut into 50 mm lengths, and the ends polished. In the centre of each sample, a 6 mm hole was drilled through each sample. The sample ends are then sealed with a lock-tite seal. The core sample is then placed between loading plates of the chamber. Axial strain is then applied to the core sample via a universal torque. Changes in the sample axial and lateral load dimensions due to gas sorption are monitored by two sets of strain gauges. Parameters that are monitored include:

- application of stress,
- measurement of strain on the sample,
- measurement of gas flow rate,
- application of constant circumferential gas pressure, and
- application of constant suction.

Gas is charged into the sealed pressure chamber at a pressure of 3 MPa and maintained constant for a period of one week to allow the coal to be sufficiently saturated. The strain is recorded for this period. In the tests reported here little change in strain was observed over the time period. Once the sample was fully saturated, the release valve was opened and released gas passed through various flow metres of differing flow rates consisting of:

- low flow range: 0 - 100 ml/minute,
- medium flow range: 0 - 2 L/minute, and
- high flow rate: 0 - 15 L/minute.

Information from the load cells, strain gauges and flow metres were monitored in a data logger connected to a PC.

RESULTS AND DISCUSSION

Gas type and pressure and coal strength relationship

Figure 5 shows the bar charts of three different gas sorption quantities in Bulli coal seam, Sydney Basin. The gases used were CH₄, CO₂ and CH₄/CO₂ (50 per cent) mixture. There is a clear trend of different gas sorption quantities in coal, with the higher sorption being of CO₂ gas.

Figure 6 shows the average values of drill speed record of coal specimens tested under both in air (ie normal atmospheric condition) and under increased gas pressures of 1500 and 3000 kPa. Ten tests were made for each sample environment. The rate of drilling of coal samples in air was relatively slower than that drilled in higher confined gas pressures. The highest values were obtained in CO₂ confinement. The increase in gas pressure to 3000 kPa also resulted in an increase in the rate of drilling.

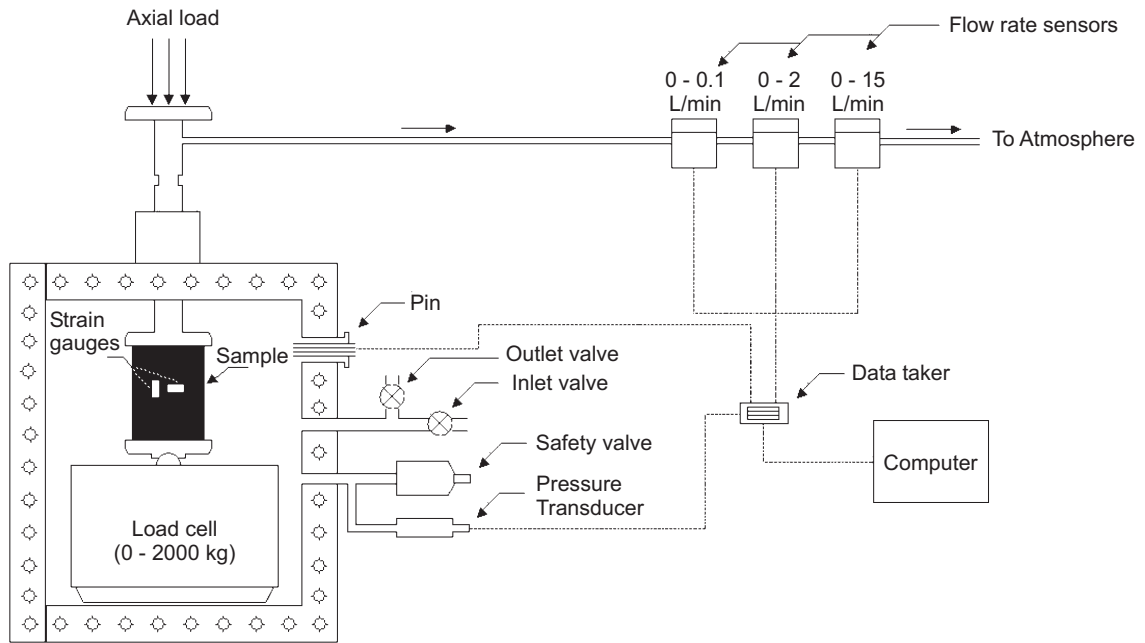

FIG 4 - Schematic diagram of permeability test rig.

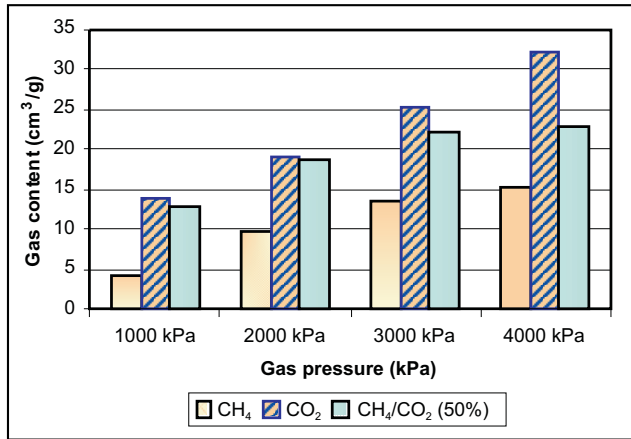

FIG 5 - Sorption levels of CH₄, CO₂, and CH₄/CO₂ at various pressures of Bulli coal seam.

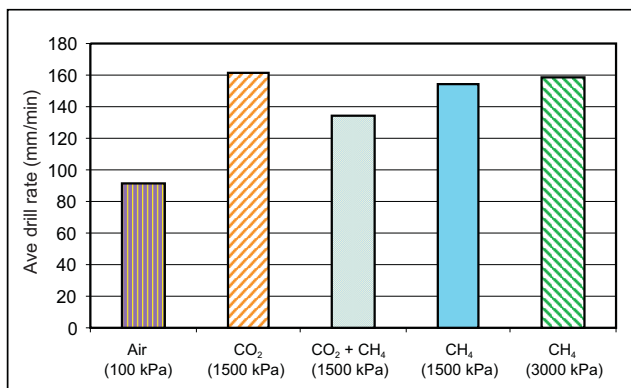

FIG 6 - Drilling rates in coal under different gas types and confining pressures.

Figure 7 shows particle size distribution of drilling cuttings in various gas pressures. The graphs represent the mean line for ten samples tested under each gas type and pressure. The particle

size distribution ranged between 0.5 μm and 878.67 μm. Drilling in air produced finer particle sizes than drilling under gas pressure confinement. Additional observations made include:

- Drilling in CO₂ environment produced coarser particle sizes than in CH₄ and CH₄/CO₂ environment at 1500 kPa pressures.
- The coarse particle size were lower in CH₄/CO₂ and even lower in CH₄ alone environment.
- Increasing CH₄ gas pressure confinement to 3000 kPa produced coarser drill cuttings. In fact the particle size distribution for CH₄ at 3000 kPa was similar to that produced from drilling in coal saturated with CO₂ gas at a confinement pressure of 1500 kPa. This is to be expected, as the increased gas pressure to 3000 kPa may have forced more gas into coal micropores leading to a reduction in surface energy of the coal.

All this indicates that the presence of confining pressure has a detrimental effect on the strength of coal. It is possible that the presence of sorbed gases in coal at higher pressures may weaken the coal tensile strength by introducing micro-fractures into the coal structure. According to established facts and reported by Gray (1995), heavily fractured and soft rocks usually produce coarse drill cuttings with high rate of drill penetration.

Coal shrinkage test results

Changes in the volume of coal matrix were calculated using the average of the two strains in the axial and radial directions. The shrinkage coefficient (C_m), is defined as the rate of change of coal matrix volume to the change in gas pressure and is given by (Harpalani and Chen, 1997):

$$C_m = \frac{1}{V_m} \left(\frac{dV_m}{dP} \right)$$

where:

- V_m = matrix volume (m³)
- dV_m = change in volume (m³)
- dP = change in applied pressure (MPa)
- C_m = shrinkage coefficient (MPa⁻¹)

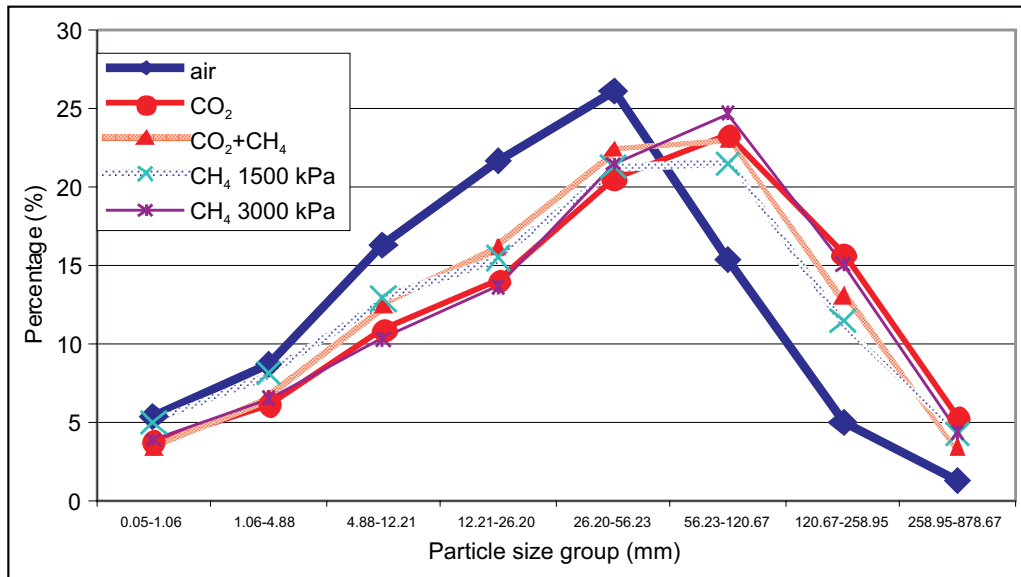

FIG 7 - Particle size distribution of drill cuttings in various gas pressures (mean lines for ten samples tested under each gas type and pressure).

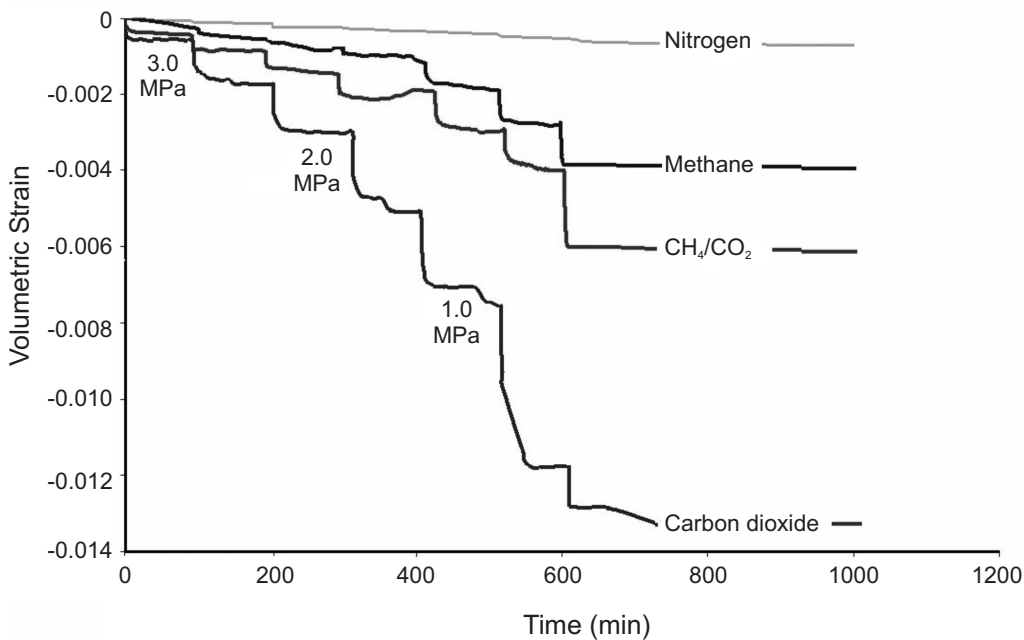

FIG 8 - Volumetric strain for different gases and pressure reductions at increments of 0.5 MPa.

Figure 8 shows the relationship between applied gas pressure and volumetric change in coal. The coal sample was initially charged to a maximum pressure of 3 MPa. The changes in coal volume were monitored in increments of 0.5 MPa. As can be seen, the reduction in coal volume is different for different gas medium. A minimal change in coal volume was measured with nitrogen while a CO₂ environment produced the highest volume change. Obviously, the influence of CO₂ reflects a strong affinity of the gas for coal. As coal adsorbs CO₂ more strongly than methane, it is thus likely the high rate of gas storage in coal is accommodated with the increase in coal volume. Clearly the change in coal volume in this case is more than five fold in CO₂ in comparison with the methane environment. The relative change in coal volume in mixed CO₂/CH₄ environment is between pure CH₄ and CO₂, but the mixture proportions influenced the degree of volume change.

Coal permeability test

Figures 9 and 10 are permeability graphs of coal samples tested in both methane and carbon dioxide gases under different gas pressures. The axial applied load was maintained constant at 2000 kg. The Bulli seam coal samples tested were collected from two geologically different locations in a local mine working Bulli seam in the Illawarra Coalfield of Sydney basin, NSW. Samples collected came from 800 panel (sample #800051) and 900 panel (sample # 900114 and #900104). The geology of these two areas at hand specimen scale is significantly different and can be described as:

1. 800 panel – ‘normal’ coal in terms of cleat spacing and orientation, orthogonal, regular spacing, normal ordered horizontal bright and dull layers, does not display visible deformation.

- 900 panel – ‘structured’ coal with broken structure, cleats often not subvertical, cleat spacing irregular, occasional small scale dislocation amongst bright and dull layers. Calcite mineralisation often found towards top of seam, usually oblique to bedding plane but tends towards bedding plane in lower parts of each vein.

From a practical perspective, gas drainage has been exceedingly difficult in the 900-panel area when compared to the 800-panel area. Management has resorted to the ‘grunching’ method of heading development using explosives, particularly where gas content levels have been greater than the allowable gas threshold limits. The coal structure has been disturbed to a point where the contained gas does not freely move from high in-seam fluid pressures to the drainage lines.

The permeability of each sample was calculated using the following Darcy flow equation (Lama, 1995):

$$K = \frac{\mu Q l n(r_0 / r_i)}{\pi l (P_0^2 - P_u^2)}$$

where:

- K = permeability (Darcy)
- l = height of sample (cm)
- Q = rate of flow of gas (cc/sec)
- P₀ = absolute pressure in chamber (bars)

- P_u = absolute pressure in outlet (bars)
- r₀ = external radius of sample (cm)
- r_i = internal radius of sample (cm)
- μ = viscosity of gas

The results showed a marked difference in the resultant permeability between the 800 and 900 panel coals. The difference in permeability (in millidarcy) between 800 panel and the 900 panel coal for each of carbon dioxide and methane is quite different. 800 panel had approximately three times greater permeability when compared to the 900 panel coals (Figures 9 and 10).

Permeability tests for both carbon dioxide and methane show that the 900 panel coals have much lower permeabilities than the 800 panel coals. Since permeability is a function of a number of parameters including size, distribution and frequency of cleats, any phenomenon that reduces cleat porosity will decrease permeability. Given that 900 panel coals contain much higher carbonate contents than the 800 panel coals, and also have the lowest permeability, it is suggested that the reduced porosity of the 900 panel coals is due to the infilling of the cleats with carbonate.

The reduced permeability value explains why the 900 panel area is much harder to degas. The carbonate in-filled cleats restrict the movement of gases from the surrounding coal to the gas drainage holes.

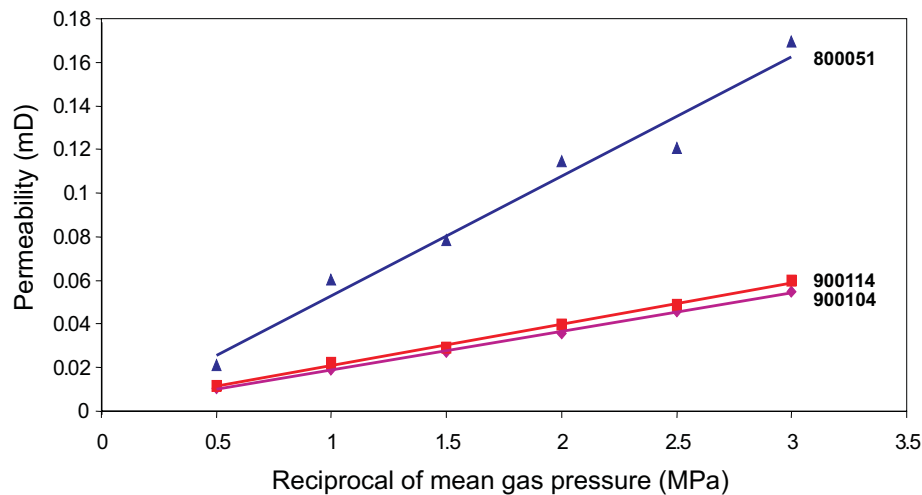

FIG 9 - Coal permeability in carbon dioxide at different gas pressures and at 2000 kg axial load.

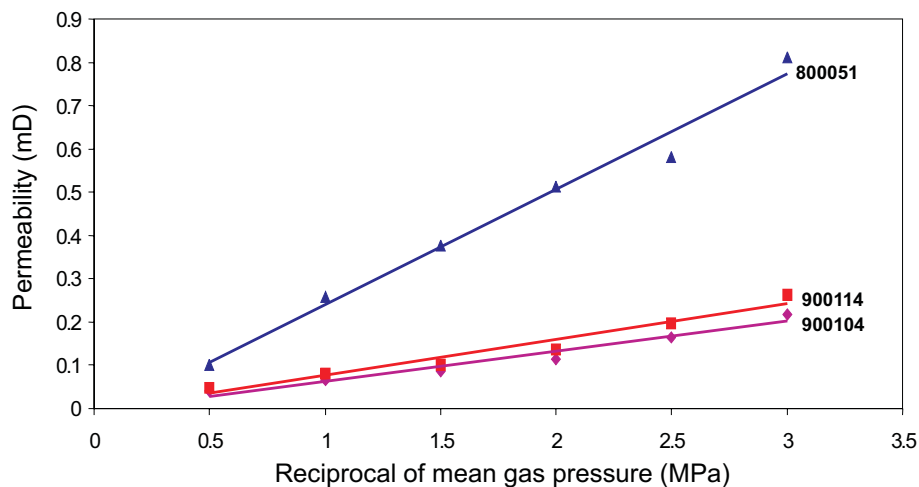

FIG 10 - Coal permeability in methane at different gas pressures and at 2000 kg axial load.

Gas flow modelling

A preliminary computational fluid dynamics (CFD) modelling exercise was carried out to ‘visualise’ the gas flow in the porous coal sample. Figure 11 shows the computational domain and the corresponding computational mesh used for the simulation. A thin slice of the coal sample was chosen as the computational domain, in order to take advantage of the axial symmetry of the sample geometry.

The computational domain is divided into a number of non-overlapping subdomains called ‘cells’. Equations describing the conservation of mass, and the Darcy equation, which replaces the momentum equations in the fluid mechanics of porous media (Bejan, 1984), are solved iteratively until balances are achieved for each computational cell. Since the cells are contiguous, this implies balances for the entire computational domain. Results are presented in the form of velocity vector plots and pressure contour plots. A typical experimental condition was chosen for the simulation. For this flow, a typical permeability value of 1 mD was used (Figure 12b). A stagnation pressure condition was applied at the inlet, and a zero gauge pressure at the outlets. For the flowing gas, CO₂, the following relevant properties at 300 K were used (Incropera and DeWitt, 1996):

- Dynamic viscosity = 149 (10⁻⁷) N-s/m²
- Density = 1.7730 kg/m³

The inlet and outlet conditions were:

- Inlet stagnation (total) pressure ~5 (10⁵) Pa (gauge)
- Outlet pressure = 0 Pa (gauge)

Figures 12a and b show the results in terms of the pressure contours through the coal sample, and the flow streamlines, respectively. The results suggest that for the above flow geometry (radially impressed flow with high stagnation pressure values, through a small axisymmetric sample with a small centrally located outlet), some of the gas exiting through the vertical sides of the central hole finds its way out from the top, while some may be trapped in the lower part of the hole. Also, it is very likely that the gas flow, under the above experimental conditions, reaches extremely high velocities as it flows through the tiny fissures and cracks in the coal sample

OUTBURST WEBSITE

ACARP is providing funds for the establishment of a website on coal/gas outburst.

The primary objective of this project is to develop an on-line coalmine outburst information management system to provide the coal mining industry with all the necessary information on outbursts via the world wide web. such a system should provide easy access to the experiences acquired by the coal mining industry. Some of the attributes of such a system must include:

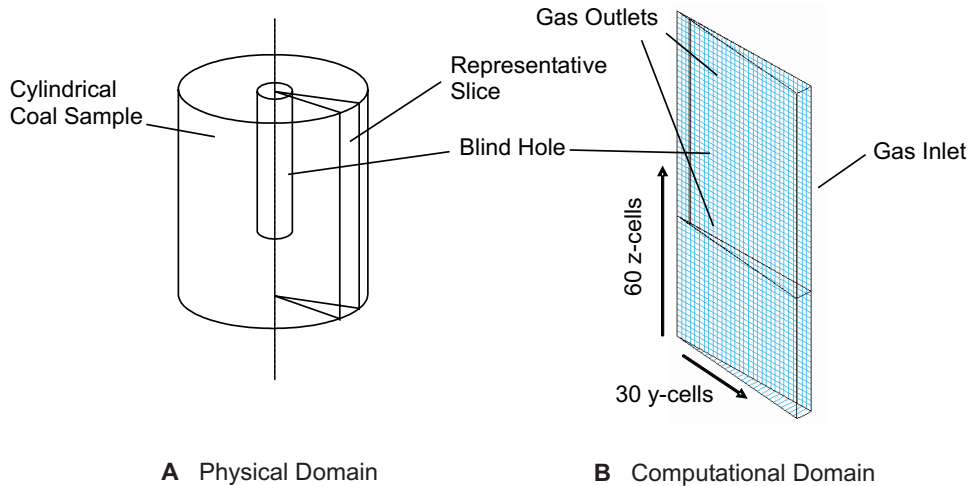

FIG 11 - Physical and computational domains for CFD simulation.

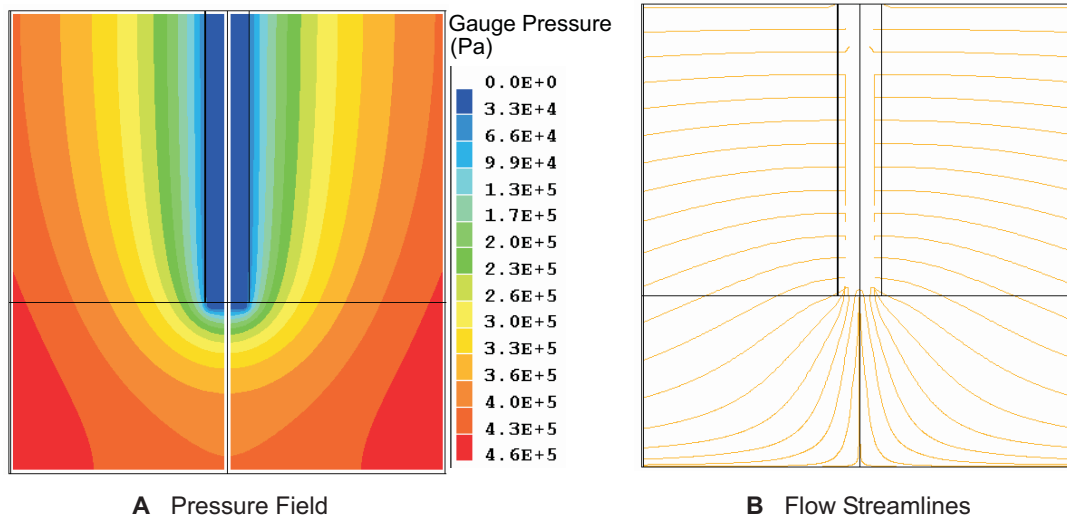

FIG 12 - Typical simulation results.

- mechanisms of outburst;
- outburst predictions and prevention;
- current management controls and compliance;
- relationships between geological structures and outburst events;
- in-seam drilling techniques;
- a virtual library of coalmine outburst with current and past literature and references;
- hyperlink to proceedings of the current and past South Coast Outburst Seminars regularly organised by outburst research committees in Illawarra;
- hyperlinks with other international websites to provide additional source information;
- ease of use and accessibility; and
- regular maintenance with current issues.

In summary, the proposed online system will electronically disseminate information on outburst for the Australian coal mining industry. It will dynamically manage both historical and current experiences of Australian and worldwide on coal mine outburst. The website (<http://cedir.uow.edu.au/Projects/outburst>) is currently at its infancy stage and is presently being upgraded gradually with new material in the coming months. The outburst website will be linked to the well known The University of Wollongong website on longwall mining (www.uow.edu.au/eng/current/longwall).

CONCLUSION

The program of research activities reported in this paper is a clear demonstration of our commitment in maintaining research on coal and gas outburst as a priority research for the benefit of the coal industry. It has been demonstrated that:

1. The study of the effect of gas pressure on coal strength through the analysis of particle sizes is a valid approach.
2. Permeability and shrinkage studies can serve as an effective approach in understanding the drainage characteristics of coal seam with intrusions and other geological disturbances. The effectiveness of these methods can be better enhanced through assessment of coal composition and mineralisation, which is the currently been enhanced.
3. The status of current research program perused at the University of Wollongong, is a continuation of the research work dating back to more than two decades. We are looking

ahead to better utilise the latest know-how and technologies for the establishment of a predictive indices for effective coal deposit mineability.

4. The establishment of an ACARP funded new website on gas and outburst management (<http://cedir.uow.edu.au/Projects/outburst>), should serve as a useful platform for disseminating the latest findings in outburst control technologies, leading to safe and efficient mining in Australia and worldwide.

REFERENCES

- Aziz, N, Hutton, A and Indraratna, B, 1996. The effect of gas pressure on coal strength, in *Proceedings 15th International Conference on Ground Control in Mining*, pp 209-226 (Colorado School of Mines: Golden).
- Aziz, N I and Ming-Li, W, 1999. The effect of sorbed gas on the strength of coal – an experimental study, *Geotechnical and Geological Engineering*, 17:387-402.
- Aziz, N I, Porter, I and Sereshki, F, 2004. The influence of gas environment on coal properties – experimental study in outburst control, in *Proceedings Fifth Underground Coal Operators' Conference, Coal Mine Planning*, pp 195-201 (University of Wollongong: Wollongong).
- Bejan, A, 1984. *Convection Heat Transfer*, pp 347-348 (John Wiley and Sons).
- Crosdale, P J, Beamish, B B and Valix, M, 1998. Coalbed methane sorption related to coal composition, *International Journal of Coal Geology*, 35:147-158.
- Gray, I, 1995. The use of drilling in outburst detection and alleviation, in *Proceedings International Symposium-cum-workshop on Management and Control of High Gas Emissions and Outbursts in Underground Coal Mines*, March, Wollongong, pp 115-122.
- Harpalani, S and Chen, G, 1997. Influence of gas production induced volumetric strain on permeability of coal, *Geotechnical and Geological Engineering*, 15:303-325.
- Incropera and DeWitt, 1996. *Fundamentals of Heat and Mass Transfer*, Fourth Edition (John Wiley and Sons).
- Lama, R D, 1995. Effect of stress, gas pressure and vacuum on permeability of Bulli coal samples, in *Proceedings International Symposium-Cum-Workshop on Management and Control of High Gas Emission and Outbursts in Underground Coal Mines*, March, Wollongong, pp 293-302.
- Nguyen, V U, 1988. Parameter identification for unified model of methane gas flow in coal, in *Proceedings VI International Conference on Numerical Methods in Geomechanics*, Innsbruck, Australia, April, pp 1937-1945.