

University of Wollongong

Research Online

---

Faculty of Engineering and Information  
Sciences - Papers: Part A

Faculty of Engineering and Information  
Sciences

---

1-1-2014

## Sodium hydroxide production from sodium carbonate and bicarbonate solutions using membrane electrolysis: A feasibility study

Alexander R. Simon

*University of Wollongong, [asimon@uow.edu.au](mailto:asimon@uow.edu.au)*

Takahiro Fujioka

*University of Wollongong, [takahiro@uow.edu.au](mailto:takahiro@uow.edu.au)*

William Price

*University of Wollongong, [wprice@uow.edu.au](mailto:wprice@uow.edu.au)*

Long Nghiem

*University of Wollongong, [longn@uow.edu.au](mailto:longn@uow.edu.au)*

Follow this and additional works at: <https://ro.uow.edu.au/eispapers>



Part of the [Engineering Commons](#), and the [Science and Technology Studies Commons](#)

---

Research Online is the open access institutional repository for the University of Wollongong. For further information contact the UOW Library: [research-pubs@uow.edu.au](mailto:research-pubs@uow.edu.au)

---

# Sodium hydroxide production from sodium carbonate and bicarbonate solutions using membrane electrolysis: A feasibility study

## Abstract

This study demonstrates the feasibility of producing NaOH from coal seam gas (CSG) brine by membrane electrolysis.

## Keywords

feasibility, sodium, hydroxide, production, carbonate, bicarbonate, solutions, membrane, study, electrolysis

## Disciplines

Engineering | Science and Technology Studies

## Publication Details

Simon, A. R., Fujioka, T., Price, W. & Nghiem, L. (2014). Sodium hydroxide production from sodium carbonate and bicarbonate solutions using membrane electrolysis: A feasibility study. *Separation and Purification Technology*, 127 (April), 70-76.

# **Sodium hydroxide production from sodium carbonate and bicarbonate solutions using membrane electrolysis: a feasibility study**

Revised Manuscript Submitted to

*Separation Purification Technology*

*Feb 2014*

Alexander Simon<sup>1</sup>, Takahiro Fujioka<sup>1</sup>, William E. Price<sup>2</sup>, Long D. Nghiem<sup>1, \*</sup>

<sup>1</sup> Strategic Water Infrastructure Laboratory, School of Civil Mining and Environmental Engineering, University of Wollongong, Wollongong, NSW 2522, Australia

<sup>2</sup> Strategic Water Infrastructure Laboratory, School of Chemistry  
University of Wollongong, Wollongong, NSW 2522, Australia

---

\* Corresponding author: Long DucNghiem, Email [longn@uow.edu.au](mailto:longn@uow.edu.au); Tel: +61 2 4221 4590

## Abstract

This study demonstrates the feasibility of producing NaOH from coal seam gas (CSG) brine by membrane electrolysis. Membrane electrolysis of  $\text{NaHCO}_3$ ,  $\text{Na}_2\text{CO}_3$ , and  $\text{NaCl}$ , which are the three dominating sources of sodium in CSG brine, were evaluated and compared. Overall, the current efficiency did not change significantly when different brine solutions (i.e.  $\text{NaCl}$ ,  $\text{NaHCO}_3$  and  $\text{Na}_2\text{CO}_3$ ) were used as feedstock. The counter ions (i.e.  $\text{Cl}^-$ ,  $\text{HCO}_3^-$  and  $\text{CO}_3^{2-}$ ) did not affect the transport of sodium ions ( $\text{Na}^+$ ) through the membrane. Similarly, no significant variation in NaOH production was observed when the three brine solutions, which contained 100 g/L of the corresponding salt each, were evaluated under the same conditions. It is noteworthy that membrane electrolysis was most effective for desalting a  $\text{NaHCO}_3$  brine solution, followed by  $\text{NaCl}$  and then  $\text{Na}_2\text{CO}_3$ . This is because of the equivalent weights (with respect to  $\text{Na}^+$ ) of these three salts decreases in the order of  $\text{NaHCO}_3$  (84 g/eq) >  $\text{NaCl}$  (58.5 g/eq) >  $\text{Na}_2\text{CO}_3$  (53 g/eq). The energy efficiency of the membrane electrolysis process with respect to NaOH production increased as the brine concentration increased. On the other hand, the desalination efficiency (or brine concentration reduction) by membrane electrolysis increased as brine concentration decreased. The results also revealed a drawback of the use of  $\text{NaHCO}_3$  as feedstock to the membrane electrolysis process. The produced NaOH solution strength obtained from  $\text{NaHCO}_3$  within a specified time was limited to about 12%, whereas that of  $\text{NaCl}$  was as high as 18%. The lower NaOH strength obtained from  $\text{NaHCO}_3$  could be attributed to lower osmotic pressure and electrical conductivity of this salt as compared to  $\text{NaCl}$ .

*Keywords:* Coal seam gas produced water, brine treatment, membrane electrolysis, chlor-alkali, sodium hydroxide, sodium bicarbonate.

## 1 Introduction

Recent coal seam gas (CSG) developments have resulted in a major shift in the global energy outlook. CSG is essentially natural gas (primarily methane) that occurs in underground coal seams. Natural gas currently accounts for 21 –25% of the global primary energy consumption [1]. With significant reserves in many parts of the world including North America, Europe, and Australia, the contribution of natural gas from coal seams to the global energy mix will continue to rise in the future. It is estimated that 70% of the global liquefied natural gas capacity under construction is taking place in Australia to tap into its vast CSG reserve [2]. Natural gas is a cleaner fuel than coal and oil; with less polluting combustion products and electricity generation can be instantaneously adjusted to match the energy demand. The latter advantage avoids unnecessary energy production and greenhouse gas emission. In addition, natural gas extraction is essential to reduce the risk of methane outburst and fugitive methane emission, which are critical for any future coal mining activities. However, CSG extraction inevitably requires the co-extraction of water (often referred to as CSG produced water) to the surface to depressurise the coal seams and allow natural gas to flow to the surface. The volume of CSG produced water is very large. For example, a recent study commissioned by the Queensland Government estimates that the volume of CSG produced water from Southern Queensland generated each year may be as much as 175 GL, with a potential accumulative volume of 5,100 GL to 2060. This CSG produced water is brackish, due to a rich mixture of salts including sodium chloride, bicarbonate or carbonate. Thus, without appropriate treatment, CSG produced water cannot be put to beneficial use or directly released into the environment due to a significant impact on the environment [3-6]. For this reason and because of the high cost of RO brine discharge, many dedicated studies have prompted the development of suitable treatment technologies for the management of RO brine [7-11]. The current CSG produced water practice consists of pre-treatment (e.g. coagulation, pH adjustment), ultra- or microfiltration, followed by reverse osmosis (RO) desalination [12]. A state of the art RO process can produce high quality treated water, suitable for a wide range of uses [6, 13]. However, produced water management remains a bottleneck in the otherwise fast growing CSG industry. The RO process can only achieve 70 – 80% water recovery. Managing CSG RO brine (which is about 20 – 30% of the initial CSG water volume) and high salinity produced water from the oil and gas industry remains a major technological challenge and only a few studies have been conducted to address this issue [14].

In most, if not all current CSG operations, the RO brine is stored in fully lined brine ponds for future treatment, which can be only considered as a temporary option due to cost and environmental risks. However, the CSG RO brine can be a potential feedstock for the extraction of saleable minerals, which result in the reduction of the volume and salinity of the CSG RO brine. Such techniques involve a further concentration of the brine to near saturation by both well-established and emerging technologies such as multi-effect distillation (MED) or membrane distillation (MD) followed by a mineral recovery step. For example, Penrice (Penrice Soda Holdings Limited, Australia) in collaboration with GE (General Electric, Australia) and QGC (QGC Pty Limited, Australia) has announced a pilot project to demonstrate the recovery of soda ash from CSG brine. Another notable technique is to use the saturated CSG brine as a feedstock for the production of sodium hydroxide using the chlor-alkali membrane electrolysis process.

The membrane electrolysis system consists of an anode and a cathode semi-cell. In the current chlor-alkali membrane electrolysis process, NaCl brine is fed into the anode, which produces aqueous NaOH, chlorine and hydrogen gas. Thus, the following reactions occur at the anode and cathode

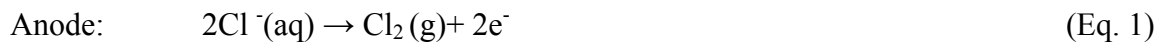

In the cathode, water is electrolysed into OH<sup>-</sup> and hydrogen gas.



A cation-exchange membrane separates the anode and cathode solutions, but is permeable to Na<sup>+</sup>. Thus, Na<sup>+</sup> can migrate across the membrane to combine with OH<sup>-</sup> in the cathode to form NaOH. The overall electrolysis reaction of NaCl to NaOH and Cl<sub>2</sub> can be written as:



Membrane electrolysis is a well-established technology for the production of NaOH (or caustic soda), which is an important raw material in many industries. Over 90% of all recently installed sodium hydroxide production capacity is based on the membrane electrolysis process [15]. To date, NaCl brine obtained from sea salts or inland salt lakes has been the only feedstock to the membrane electrolysis. The emergence of seawater desalination as a major source of drinking water supply has presented the chlor-alkali industry with a unique opportunity. In a recent study, Melian-Martel et al. [16], demonstrate that membrane electrolysis can not only use the NaCl rich

brine, which is double the concentration of seawater, but also provide a sustainable solution to the management of RO brine disposal from seawater desalination plants. In addition to the brine from seawater desalination applications, CSG brine may also be a suitable feedstock for the membrane electrolysis process. However, to date, all research efforts in membrane electrolysis have focused only on NaCl feedstock. Little is known about the commercial use of NaHCO<sub>3</sub> and Na<sub>2</sub>CO<sub>3</sub>, which are two dominating sources of sodium in CSG brine, in membrane electrolysis.

The purpose of this study was to determine the feasibility of producing NaOH by membrane electrolysis using CSG brine. Current efficiency of the electrolytic process of NaCl, NaHCO<sub>3</sub>, and Na<sub>2</sub>CO<sub>3</sub>, which are usually the dominant species of salts in CSG water, were evaluated and compared. The effects of current density and flow rate upon the current efficiency, NaOH production, decrease in brine concentration, and the energy consumption were systematically investigated.

## **2 Materials and Methods**

### **2.1 Selected cation exchange membrane**

A cation exchange membrane (Selemion CMF, AGC Engineering Ltd, Tokyo, Japan) was used in this study. According to the manufacturer, this is a high durability membrane for electrolysis application. The membrane has a thickness of 440 μm and a very low electrical resistance (2.5 Ω/cm<sup>2</sup> at 0.5 M NaCl and 25 °C). The transport number of Na<sup>+</sup> (which is defined as the current carried by the specified ion over the total current of the CMF membrane) is above 0.95

### **2.2 Brine solutions**

Brine solutions were prepared by dissolving analytical grade NaCl, NaHCO<sub>3</sub> and Na<sub>2</sub>CO<sub>3</sub> (supplied by Chem-Supply, Gillman, South Australia) in Milli-Q water. NaHCO<sub>3</sub> and Na<sub>2</sub>CO<sub>3</sub> are the two most abundant salts in CSG water reported in the literature [12]. In fact, in a recent pilot study using a combination of RO and MED, we were able to achieve 95% water recovery from CSG produced water from a pilot gas field in northern New South Wales (Australia). The concentrations of Na<sup>+</sup>, HCO<sub>3</sub><sup>-</sup>, and Cl<sup>-</sup> in the remaining brine were 17.0, 19.7, and 2.2 g/L, respectively. It is noteworthy that NaHCO<sub>3</sub> has the lowest solubility (Table 1). At the same mass concentration of 10%, NaHCO<sub>3</sub> also has the lowest electrical conductivity.

**[TABLE 1]**

### **2.3 Membrane electrolysis system and experimental protocol**

The membrane electrolysis system (Figure 1) used consisted of an electrolysis cell (Model E-0, AGC Engineering Ltd, Japan), two peristaltic pumps (Masterflex, John Morris Scientific Pty Ltd, Australia), a programmable power supplier (Model PSH-2018A, GW Instek, Taiwan), and a gas separator. The membrane electrolysis cell included an anode and a cathode semi-cell with an active membrane surface area and channel height of 200 cm<sup>2</sup> and 0.2 cm, respectively. The anode and cathode materials were galvanised titanium and type 316 stainless steel, respectively. The flow rate of the anode (feedstock) and cathode (water) semi-cells can be independently controlled within the range of 18 – 1200 mL/min by the peristaltic pumps. The programmable power supply is capable to deliver up to 18 A (equivalent to 900 A/m<sup>2</sup>) at the maximum voltage of 20 V (DC). The gas separator divided the processed brine solution from the chlorine gas.

#### **[FIGURE 1]**

At the beginning of each membrane electrolysis experiment, the anode semi-cell was filled with the brine solution and the cathode semi-cell was filled with Milli-Q water. The anode and cathode flow rates as well as the current were then adjusted to the required values. When conducting experiments with various current densities, the flow rate was maintained at 0.4 L/hour (equivalent to a cross-flow velocity of 0.03 m/min). At each experimental condition, the system was stabilized for at least 15 minutes, which corresponds to 2.5 times the residence time of the brine solution within the membrane cell at a flow rate of 0.4 L/hour, before the samples were collected for analysis. The depleted brine and generated NaOH were not returned to the membrane electrolysis cell for experiments used to evaluate the impact of current density and brine concentration on the NaOH production. To test the ability to generate higher concentrated NaOH solutions, Milli-Q water (0.4 L) was used as the initial cathode solution and the products were recirculated as the membrane electrolysis experiment progressed.

### **2.4 Analytical measurements**

The production of NaOH was determined by a gravimetric method. Briefly, 20 mL of cathode sample was placed in an oven at 100 °C until a constant mass was obtained (i.e. all liquid was evaporated). The mass of dry NaOH solid was then measured using an analytical balance. It is noteworthy that this gravimetric method produces the same results as the pH titration method.



However, for high strength NaOH samples, the gravimetric method is significantly less labour intensive and used smaller amounts of reagents compared to pH titration.

Changes in the brine concentration before and after membrane electrolysis were determined by conductivity measurement using an Orion 4 Star Plus pH/conductivity meter (Thermo scientific, Waltham, Massachusetts, USA). The brine concentration was linearly correlated to electrical conductivity. Thus, the decrease in brine concentration ( $C_{db}$ ) after membrane electrolysis was calculated as:

$$C_{db} (g / L) = \left(1 - \frac{S_a}{S_b}\right) \times C_b \quad (\text{Eq. 4})$$

where  $C_b$  is the concentration before the experiment, and  $S_b$  and  $S_a$  are electrical conductivity of the brine before and after the experiment, respectively.

### 3 Theory

Sodium bicarbonate ( $\text{NaHCO}_3$ ), sodium carbonate ( $\text{Na}_2\text{CO}_3$ ), and sodium chloride ( $\text{NaCl}$ ) are the three most abundant minerals in CSG produced water and thus in CSG RO brine, and their proportions in the CSG water usually vary from one gas field to another. Experiments were conducted with 100 g/L of each salt, which should simulate the strength of CSG water obtained from a pilot gas field in northern New South Wales (Australia) after the treatment by RO (75% recovery) followed by either MED or MD (80% recovery). This is also similar to the saturated  $\text{NaHCO}_3$  brine solution of 105 g/L at a temperature of 25 °C (Table 1). During membrane electrolysis, sodium ions ( $\text{Na}^+$ ) permeate from the anode cell through the cation exchange membrane toward the cathode. The cathode cell produces hydroxide ions ( $\text{OH}^-$ ), which combines with  $\text{Na}^+$  to form sodium hydroxide ( $\text{NaOH}$ ). Unlike the chlor-alkali process, which uses  $\text{NaCl}$  as the feed, when the brine contains  $\text{NaHCO}_3$  or  $\text{Na}_2\text{CO}_3$ ,  $\text{CO}_2$  and  $\text{O}_2$  are produced at the anode. The overall chemical reactions representing the electrolysis  $\text{NaHCO}_3$  and  $\text{Na}_2\text{CO}_3$  can be written as below.

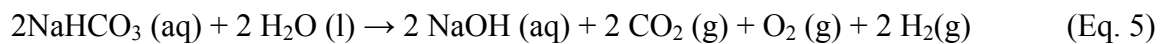



The transport rate of  $\text{Na}^+$  ions through a cation exchange membrane follows Faraday's law and increases proportionally to the applied current:

$$N(\text{mol} / \text{s}) = \frac{I}{F} \quad (\text{Eq.7})$$

Where  $N$  is the molar transport rate of cations through the membrane,  $I$  is the applied current (A) and  $F$  is the Faraday constant (96485 C/M). When the brine solution flow rate ( $U_{brine}$ ), anode chamber volume ( $V_{anode}$ ) and the current efficiency ( $\mathcal{E}$ ) of the electrolysis process are introduced, equation 7 can be rearranged to express the overall molar transport of  $\text{Na}^+$  cations through the membrane ( $N_{overall}$ ):

$$N_{overall}(\text{mol}) = \frac{I \times \frac{V_{anode}}{U_{brine}} \times \mathcal{E}}{F} \quad (\text{Eq.8})$$

The current efficiency ( $\mathcal{E}$ ) coefficient is given by [17]:

$$\mathcal{E} = \frac{U_{brine} \times F \times (C_{in} - C_{out})}{I \times A} \quad (\text{Eq.9})$$

Where  $A$  is the membrane surface area,  $I$  is the applied current density ( $\text{A}/\text{m}^2$ ), and  $C_{in}$  and  $C_{out}$  are the equivalent cation ( $\text{Na}^+$ ) concentration at the inlet and outlet of the anode cell, respectively. Equations 8 and 9 represent a simple model to simulate the production of NaOH under different operating conditions (e.g. various current densities and brine flow rates).

## 4 Results and discussion

### 4.1 Current efficiency

The depletion of  $\text{Na}^+$  between the inlet and outlet of the anode cell was used to calculate the current efficiency following equation 9. The results in Figure 2 show that both  $\text{NaHCO}_3$  and  $\text{Na}_2\text{CO}_3$  can be used as the feed solution for membrane electrolysis without any significant reduction in process efficiency. Overall, the current efficiencies of these two salts are similar to NaCl. There was no conclusive and notable impact of current density on current efficiency when NaCl or  $\text{Na}_2\text{CO}_3$  solutions were used as the feed. The current efficiency of the  $\text{NaHCO}_3$  solution

was very low (32 %) at a small current density and increased to the same level as that of NaCl and Na<sub>2</sub>CO<sub>3</sub> (55 ± 5 %) as the current density increased beyond 400 A/m<sup>2</sup>. This could possibly be attributed to the low conductivity of the NaHCO<sub>3</sub> brine solution in comparison to that of NaCl and Na<sub>2</sub>CO<sub>3</sub> (Table 1). As current density increased, the impact of ionic strength became less important and thus the current efficiency of NaHCO<sub>3</sub> increased. Overall, the current efficiency of the three brine solutions investigated is about 50%, which is consistent with the range of 45 to 75% previously reported by Kruissink [18]. It is noteworthy that current efficiency is dependent on heat loss, transport of other cations in the system such as H<sup>+</sup>, current loss in the membrane cell isolation, back diffusion of Na<sup>+</sup> ions into the anode chamber, and the non-ideal selectivity of the membrane [17]. In addition, gas bubbles in the system and electro-osmotic water transport through the membrane can impact the current efficiency of the system [18, 19]. In a full scale chlor-alkali membrane electrolysis installation, where higher temperatures and current densities can be used, the negative influence of these factors can be mitigated [20-22], resulting in higher current efficiency than those reported in this study and by Kruissink [18].

## [FIGURE 2]

### 4.2 Sodium hydroxide production from different brine solutions

The production of NaOH as a function of current density using NaCl, NaHCO<sub>3</sub> and Na<sub>2</sub>CO<sub>3</sub> brine solutions is shown in Figure 3a. The strength of each brine solution was set at 100 g/L (equivalent to molar concentration of sodium of 1.71, 1.16 and 1.88 M, respectively), which is approximately the maximum solubility of NaHCO<sub>3</sub> (Table 1). In addition, it has also been observed that CSG brine of at least 100 g/L can be obtained from a treatment train consisting of pretreatment, ultrafiltration, RO and either MED or MD with very little fouling/scaling (data not shown). The rates of NaOH production from these three different brine solutions were almost identical. These results are in good agreement with the similar current efficiencies obtained from these three salts reported above.

The results from Figure 3a suggest that counter ions (i.e. Cl<sup>-</sup>, HCO<sub>3</sub><sup>-</sup> and CO<sub>3</sub><sup>2-</sup>) do not influence the transport of Na<sup>+</sup> through the membrane. However, these counter ions can influence the rate of brine concentration reduction. Indeed, the reduction in brine concentration was in the decreasing order of NaHCO<sub>3</sub> > NaCl > Na<sub>2</sub>CO<sub>3</sub>. This is consistent with the order of the equivalent weights (with respect to Na<sup>+</sup>) of these three salts (i.e. 84, 58.5, and 53 g/eq for

NaHCO<sub>3</sub>, NaCl, and Na<sub>2</sub>CO<sub>3</sub>, respectively). The results reported here suggest that membrane electrolysis can not only produce NaOH from a bicarbonate rich brine solution but also be effective for reducing the salinity of such brine.

It is, however, noteworthy that the energy efficiency for the production of NaOH from NaHCO<sub>3</sub> and Na<sub>2</sub>CO<sub>3</sub> is less favorable as in comparison to NaCl (Figure 3c). This can be attributed to the lower electrical conductivity of the NaHCO<sub>3</sub> and Na<sub>2</sub>CO<sub>3</sub> solution compared to the NaCl solution (Table 1). A brine solution of low conductivity requires a higher applied voltage to overcome the electrical resistance, and thus more energy is required in the electrolysis process (Figure 3c). Energy requirements for the electrolysis of 100 g/L NaCl, Na<sub>2</sub>CO<sub>3</sub> and NaHCO<sub>3</sub> (at 10 A, flow rate of 0.4 L/hour) were 114, 120 and 130 W, respectively. These results are consistent with the different conductivities of the brine solutions (Table 1). It is also noteworthy that the energy efficiency decreased with the applied current density, which is possibly because of the enhanced gas production (Figure 3c).

### [FIGURE 3]

#### 4.3 Effect of brine concentration

In addition to the production of NaOH, the application of membrane electrolysis for CSG produced water management also aims to reduce the brine concentration. Thus, it is essential to assess the reduction in brine concentration that can be achieved by membrane electrolysis. Because the maximum solubility of NaHCO<sub>3</sub> (which is the most abundant species in CSG produced water) is only 105 g/L at 25 °C (Table 1), brine solution containing NaCl in the range from 50 to 200 g/L was used for evaluating the impact of brine concentration on NaOH production and salinity reduction. Results presented in Figure 4a show that brine concentration had no significant impact on the rate of NaOH production. A small, but nevertheless discernible, increase in the NaOH production rate was observed with the highest brine concentration of 200 g/L NaCl (Figure 4a). This is likely due to an enhanced current efficiency as a result of the higher solution conductivity [21]. In agreement with the rate of NaOH production, the absolute brine reduction (in g/L) was also proportional to the applied current density and only varied slightly when different brine concentrations were used (Figure 4b).

The impact of brine concentration and current density on the energy efficiency of NaOH production (measured as M/W) was also investigated. NaOH production per unit energy

decreased with increasing current density (Figure 4c). This phenomenon is possibly caused by the enhanced gas production (in the form of bubbles) within the membrane cell. The formation of bubbles reduces the effective membrane surface area [23] and the conductivity of the membrane cell [19]. Overall, brine concentration of 200 g/L appeared to result in slightly higher energy efficiency compared to a lower brine strength, particularly at a high current density (Figure 4c). The higher energy efficiency obtained from a high brine concentration could be attributed to the high electrical conductivity, which resulted in a lower applied voltage during the electrolysis process. The results suggest that CSG brine in the range from 50 to 100 g/L can be used for membrane electrolysis without any significant impact on NaOH production, salt reduction rate in the feed, and energy efficiency.

#### [FIGURE 4]

While the initial brine concentration has no significant impact on the rate of NaOH production, the impact on desalination efficiency (reduction in brine concentration as a percentage) was consequently significant (Figure 5). Because the transport of  $\text{Na}^+$  through the membrane did not vary when using brine solutions of different concentrations (Figure 4b), desalination efficiency increased as the brine concentration decreased. Therefore, membrane electrolysis could result in a desalination efficiency of 94% when the initial brine concentration was as low as 50 g/L NaCl. By contrast, the desalination efficiency of a brine containing 200 g/L NaCl was only 30%. Data from Figure 4c and Figure 5 suggest that there is a trade-off between energy and solution desalination efficiency when determining the concentration of the feedstock to the membrane electrolysis process. In addition, the results reported here also demonstrate that membrane electrolysis can be effective for reducing the concentration of CSG water, which is concentrated by RO (75 % recovery), followed by MD or MED (80 % recovery).

#### [FIGURE 5]

#### 4.4 Production of concentrated NaOH

Higher concentrated NaOH solutions are usually produced by circulating the cathode solution through the membrane cell (this corresponds partly to a discontinuing or “feed and bleed” operating method [17]). In this study, 0.4 L of cathode solution was circulated to assess the NaOH concentration rate using 100 g/L NaCl and  $\text{NaHCO}_3$ . The results obtained from 100 g/L of brine solution using NaCl and  $\text{NaHCO}_3$  as the feedstock are shown in Figure 6. In both cases,

the strength of the NaOH solution increased almost linearly as a function of time. After seven hours of continuous electrolysis, the NaOH solution strength reached 4.7 M/L (or 18.6%) when using NaCl as the feedstock. On the other hand, when using NaHCO<sub>3</sub> as the feedstock, the obtained NaOH solution strength appeared to plateau after six to seven hours of electrolysis operation at a concentration of 3.2 M/L (or 12.8%). This may be attributed to several factors. Firstly, at the same mass concentration, a NaCl brine solution has more sodium and higher conductivity than that of a NaHCO<sub>3</sub> brine solution. Secondly, electro-osmosis can lead to the transport of water from the anode through the membrane to the cathode, thus, diluting the NaOH solution [17]. Electro-osmosis is an inherent phenomenon in membrane electrolysis, which is caused by the hydration of Na<sup>+</sup> and allows water to be transported through the membrane. Finally, the transport of water by osmosis (osmotic pressure difference between anode and cathode) could be also responsible for the different NaOH concentration profile versus time when using NaCl and NaHCO<sub>3</sub>. In fact, the osmotic pressure at 25 °C of a 100g/L NaHCO<sub>3</sub> solution is considerably lower than that of a NaCl solution with the same mass concentration. When the osmotic pressure of the produced NaOH solution is higher than that of the brine solution, water from the brine solution can permeate through the membrane, thus, adversely affecting the increase in NaOH concentration in the anode. In fact, we have observed an increase of 50 mL/hour of the initial cathode solution when using the NaHCO<sub>3</sub> brine solution, whereas the observed increase in the cathode solution was only 23 mL/hour when the NaCl brine solution was used. The results reported here demonstrate the feasibility of producing NaOH with a strength of over 3 M/L (or 12%) from a NaHCO<sub>3</sub> brine solution under the current operating conditions.

## [FIGURE 6]

## 5 Conclusion

The results demonstrate the feasibility of NaOH production from NaHCO<sub>3</sub> and Na<sub>2</sub>CO<sub>3</sub>, which are, with NaCl, the dominating sources of sodium in coal seam gas produced water brine using membrane electrolysis. Overall, the current efficiency of the membrane electrolysis cell did not change significantly when different brine solutions (i.e. NaCl, NaHCO<sub>3</sub> and Na<sub>2</sub>CO<sub>3</sub>) were used as the feed. The results suggest that the counter ions (i.e. Cl<sup>-</sup>, HCO<sub>3</sub><sup>-</sup> and CO<sub>3</sub><sup>2-</sup>) do not influence the transport of Na<sup>+</sup> through the membrane. No significant variation in NaOH production was

observed when the three brine solutions each containing 100 g/L of the corresponding salt were evaluated under the same conditions. The desalination efficiency by membrane electrolysis decreased in the order of  $\text{NaHCO}_3 > \text{NaCl} > \text{Na}_2\text{CO}_3$ . This is because of the increasing weight % of sodium in these three salts. In addition, there is a trade-off between energy and desalination efficiency. The energy efficiency of the membrane electrolysis process increased as the brine concentration increased. Conversely, the desalination efficiency by membrane electrolysis increased as brine concentration decreased. The results also indicate a drawback of using  $\text{NaHCO}_3$  as feedstock for membrane electrolysis. The produced NaOH solution strength obtained from  $\text{NaHCO}_3$  was limited to about 12% and was considerably lower than that from NaCl. The low NaOH strength obtained from  $\text{NaHCO}_3$  brine may be attributed to lower osmotic pressure and electrical conductivity when compared to NaCl brine of equal concentration.

## 6 Acknowledgements

This study was supported by the National Centre of Excellence in Desalination Australia (with industry support from AGL Australia, Sasakura Engineering Corp, Aquastill, and Osmoflo). AGC Engineering Ltd (Tokyo, Japan) is thanked for the provision of membrane samples and assisting with the construction of the membrane electrolysis system.

## 7 References

- [1] World Energy Outlook 2011: Are We Entering A Golden Age of Gas?, in, IEA, Paris, 2011, pp. 1-131.
- [2] F. Umbach, The unconventional gas revolution and the prospects for Europe and Asia, *Asia Eur. J.*, (2013) 1-18.
- [3] I. Hamawand, T. Yusaf, S.G. Hamawand, Coal seam gas and associated water: A review paper, *Renew. Sust. Energ. Rev.*, 22 (2013) 550-560.
- [4] W.N. Davis, R.G. Bramblett, A.V. Zale, Effects of coalbed natural gas development on fish assemblages in tributary streams of the Powder and Tongue rivers, *Freshwater Biol.*, 55 (2010) 2612-2625.
- [5] R. Sivanpillai, S.N. Miller, Improvements in mapping water bodies using ASTER data, *Ecol. Inform.*, 5 (2010) 73-78.
- [6] C. Fritzmann, J. Löwenberg, T. Wintgens, T. Melin, State-of-the-art of reverse osmosis desalination, *Desalination*, 216 (2007) 1.
- [7] Y. Zhang, K. Ghyselbrecht, R. Vanherpe, B. Meesschaert, L. Pinoy, B. Van der Bruggen, RO concentrate minimization by electrodialysis: Techno-economic analysis and environmental concerns, *J. Environ. Manage.*, 107 (2012) 28-36.
- [8] Y. Zhang, K. Ghyselbrecht, B. Meesschaert, L. Pinoy, B. Van der Bruggen, Electrodialysis on RO concentrate to improve water recovery in wastewater reclamation, *J. Membr. Sci.*, 378 (2011) 101-110.
- [9] B. Van Der Bruggen, L. Lejon, C. Vandecasteele, Reuse, treatment, and discharge of the concentrate of pressure-driven membrane processes, *Environ. Sci. Technol.*, 37 (2003) 3733-3738.



- [10] A. Pérez-González, A.M. Urriaga, R. Ibáñez, I. Ortiz, State of the art and review on the treatment technologies of water reverse osmosis concentrates, *Water Res.*, 46 (2012) 267-283.
- [11] A. Neilly, V. Jegatheesan, L. Shu, Evaluating the potential for zero discharge from reverse osmosis desalination using integrated processes - A review, *Desal. Wat. Treat.*, 11 (2009) 58-65.
- [12] D.L. Nghiem, T. Ren, N. Aziz, I. Porter, G. Regmi, Treatment of coal seam gas produced water for beneficial use in Australia: A review of best practices, *Desal. Wat. Treat.*, 32 (2011) 316–323.
- [13] P. Xu, J.E. Drewes, D. Heil, Beneficial use of co-produced water through membrane treatment: technical-economic assessment, *Desalination*, 225 (2008) 139-155.
- [14] D.L. Shaffer, L.H. Arias Chavez, M. Ben-Sasson, S. Romero-Vargas Castrillón, N.Y. Yip, M. Elimelech, Desalination and Reuse of High-Salinity Shale Gas Produced Water: Drivers, Technologies, and Future Directions, *Environ. Sci. Technol.*, 47 (2013) 9569-9583.
- [15] S. Savari, S. Sachdeva, A. Kumar, Electrolysis of sodium chloride using composite poly(styrene-co-divinylbenzene) cation exchange membranes, *J. Membr. Sci.*, 310 (2008) 246-261.
- [16] N. Melián-Martel, J.J. Sadhwani, S. Ovidio Pérez Báez, Saline waste disposal reuse for desalination plants for the chlor-alkali industry: The particular case of pozo izquierdo SWRO desalination plant, *Desalination*, 281 (2011) 35-41.
- [17] T. Melin, R. Rautenbach, *Membranverfahren, Grundlagen der Modul- und Anlagenauslegung*, Springer Verlag, Heidelberg, 2007.
- [18] C.A. Kruissink, The effect of electro-osmotic water transport on current efficiency and cell performance in chlor-alkali membrane electrolysis, *J. Membr. Sci.*, 14 (1983) 331-366.
- [19] M. Chikhi, M. Rakib, P. Viers, S. Laborie, A. Hita, G. Durand, Current distribution in a chlor-alkali membrane cell: experimental study and modeling, *Desalination*, 149 (2002) 375-381.
- [20] C.A. Linkous, H.R. Anderson, R.W. Kopitzke, G.L. Nelson, Development of new proton exchange membrane electrolytes for water electrolysis at higher temperatures, *Int. J. Hydrogen. Energ.*, 23 (1998) 525-529.

- [21] A.A. Jalali, F. Mohammadi, S.N. Ashrafizadeh, Effects of process conditions on cell voltage, current efficiency and voltage balance of a chlor-alkali membrane cell, *Desalination*, 237 (2009) 126-139.
- [22] F. Faverjon, G. Durand, M. Rakib, Regeneration of hydrochloric acid and sodium hydroxide from purified sodium chloride by membrane electrolysis using a hydrogen diffusion anode-membrane assembly, *J. Membr. Sci.*, 284 (2006) 323-330.
- [23] Y. Xiong, L. Jialing, S. Hong, Bubble effects on ion exchange membranes — an electrochemical study, *J. Appl. Electrochem.*, 22 (1992) 486-490.

## LIST OF CAPTIONS

**Figure 1:** Schematic diagram of the membrane electrolysis system.

**Figure 2:** Current efficiency as a function of current density. The feedstock contained 100 g/L NaCl, NaHCO<sub>3</sub> or Na<sub>2</sub>CO<sub>3</sub>. The anode and cathode circulation flow rates were both 0.4 L/hour.

**Figure 3:** a) NaOH production, b) Reduction in the brine solution concentration, and c) Energy efficiency of the production of NaOH as a function of current density. The anode and cathode circulation flow rates were both 0.4 L/hour (or 0.03 m/min) each. Error bars represent standard deviation of duplicate experiments.

**Figure 4:** a) NaOH production, b) Reduction in the brine solution concentration, and c) Energy efficiency of NaOH production at different NaCl brine concentrations as a function of current density. The anode and cathode circulation flow rates were both 0.4 L/hour.

**Figure 5:** Desalination efficiency by membrane electrolysis at different initial brine concentrations. Experiments were conducted at a current density of 900 A/m<sup>2</sup>. The anode and cathode circulation flow rates were both 0.4 L/hour.

**Figure 6:** Concentration of the produced NaOH as a function of electrolysis time. The feedstock contains 100 g/L NaCl or NaHCO<sub>3</sub>. The initial cathode volume, anode and cathode flow rate, and current density were 0.4 L, 0.4 L/hour each and 500 A/m<sup>2</sup>, respectively. Error bars represent standard deviation of two replicate experiments.

## TABLES

**Table 1:** Physical properties of selected salt

Salt	Molecular weight (g/mol)	Solubility at 25 °C (g/L)	Conductivity of 10% (wt/wt) brine at 25 °C (mS/cm)
NaCl	58.44	362	130
NaHCO <sub>3</sub>	84	105	55
Na <sub>2</sub> CO <sub>3</sub>	106	307	79

# FIGURES

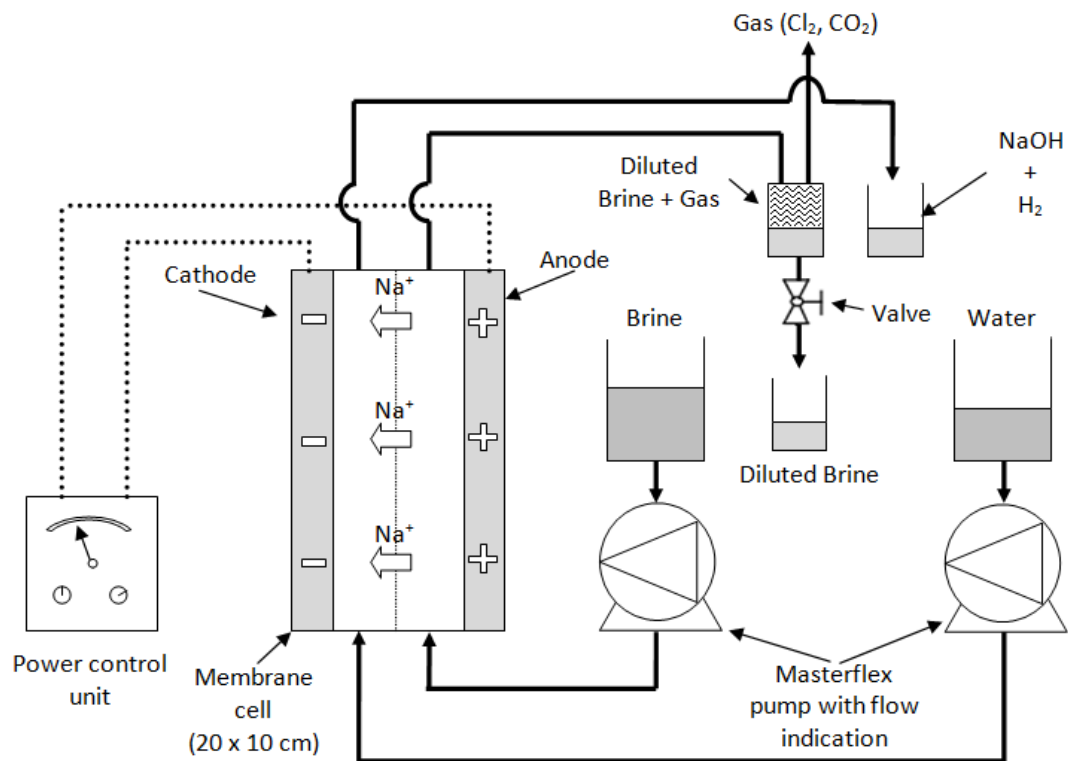

Figure 1

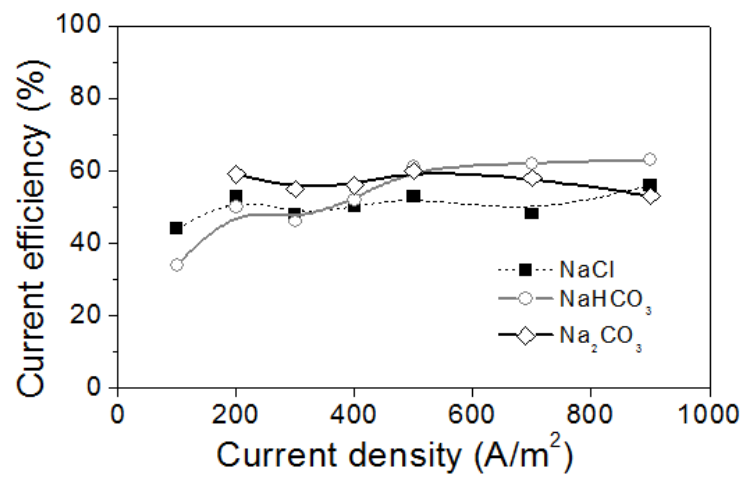

Figure 2

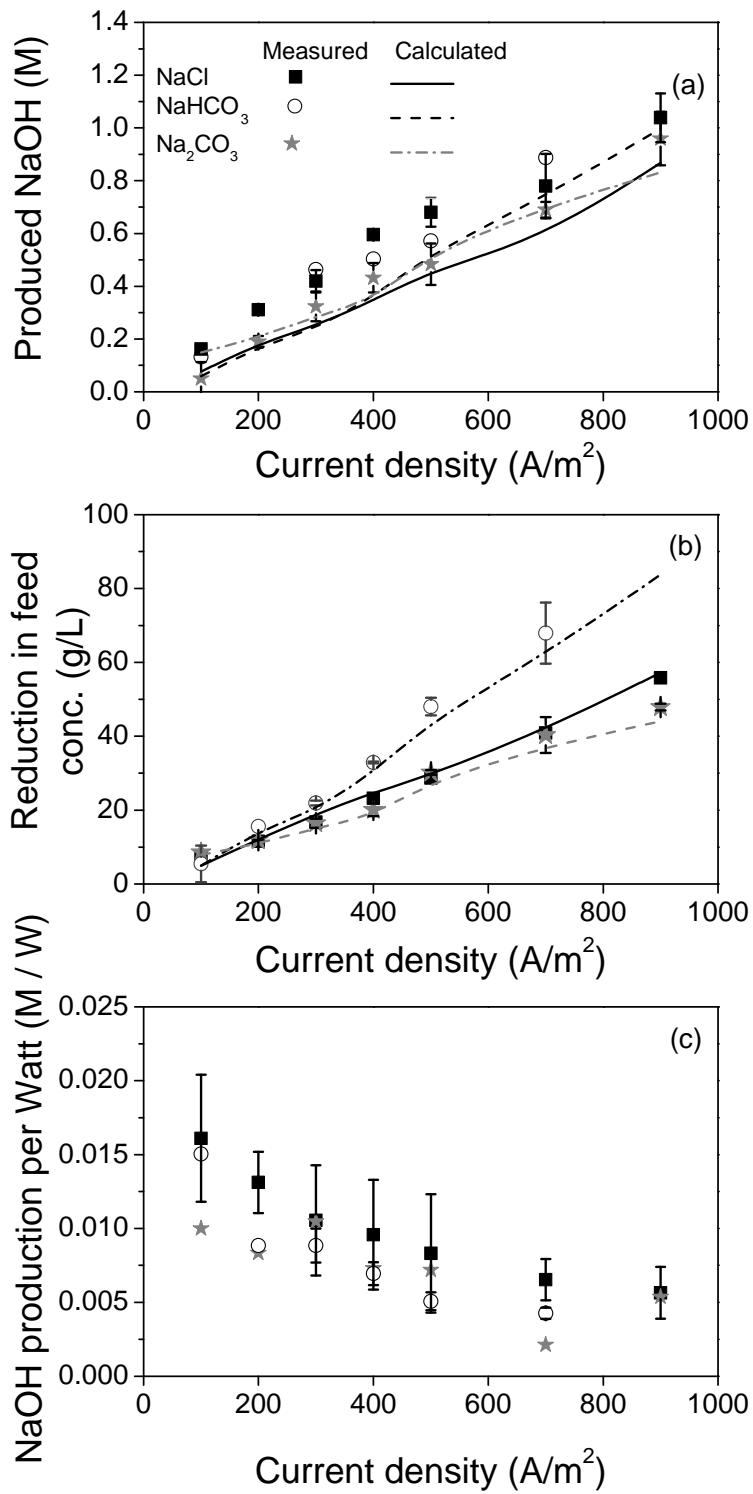

Figure 3

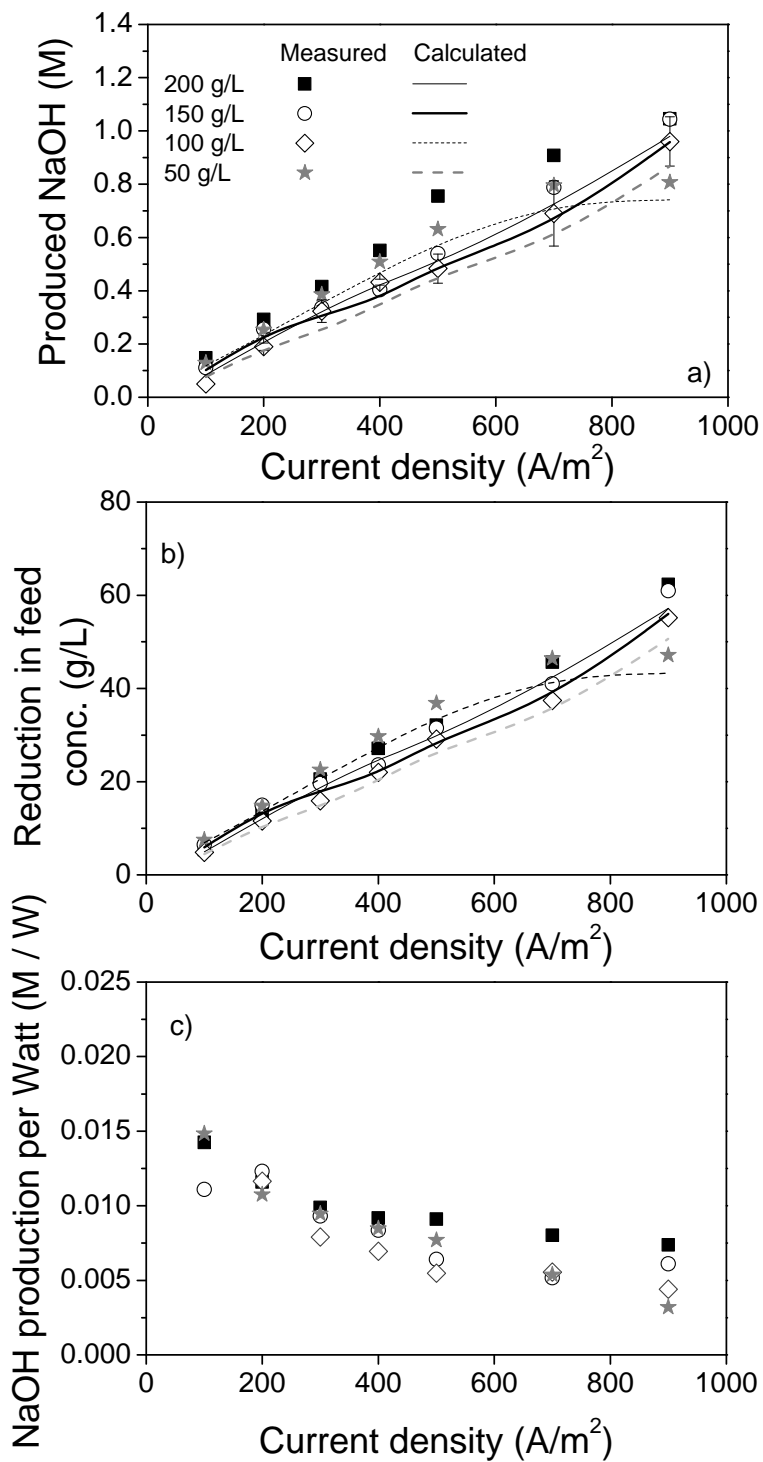
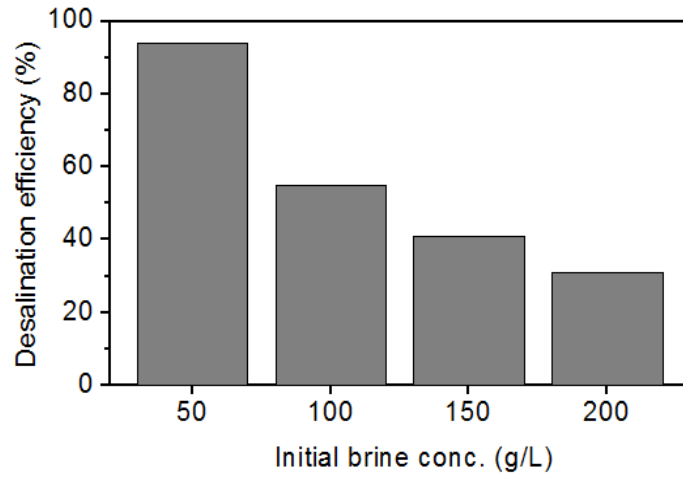
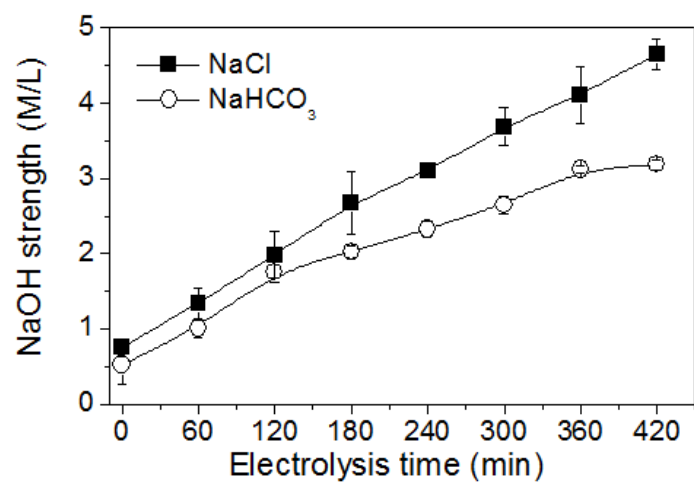

Figure 4





**Figure 5**



**Figure 6**