

University of Wollongong

Research Online

Faculty of Engineering and Information
Sciences - Papers: Part A

Faculty of Engineering and Information
Sciences

1-1-2013

Power sharing among multiple solar photovoltaic (PV) systems in a radial distribution feeder

Brian K. Perera

University of Wollongong, bkp389@uowmail.edu.au

Philip Ciufu

University of Wollongong, ciufu@uow.edu.au

Follow this and additional works at: <https://ro.uow.edu.au/eispapers>



Part of the [Engineering Commons](#), and the [Science and Technology Studies Commons](#)

Recommended Citation

Perera, Brian K. and Ciufu, Philip, "Power sharing among multiple solar photovoltaic (PV) systems in a radial distribution feeder" (2013). *Faculty of Engineering and Information Sciences - Papers: Part A*. 2011. <https://ro.uow.edu.au/eispapers/2011>

Research Online is the open access institutional repository for the University of Wollongong. For further information contact the UOW Library: research-pubs@uow.edu.au

Power sharing among multiple solar photovoltaic (PV) systems in a radial distribution feeder

Abstract

With an increasing penetration of solar photovoltaic (PV) systems, power distribution grids are becoming more susceptible to network voltage rise. As per applicable standards for grid-integrated PV systems, a PV system must be automatically disconnected from the grid when the terminal voltage of the PV system exceeds a defined maximum voltage. With this directive, in certain situations, PV systems connected at nodes at which the voltage sensitivity is high, may be disconnected from the grid while PV systems connected at less sensitive nodes are continuing to operate. In such a situation, owners whose PV systems are connected at nodes at which the voltage sensitivity is high, may lose their revenue. In order to minimise such a disadvantage, the current research proposes a power sharing methodology for PV systems that are connected to a radial distribution feeder by allocating a grid voltage bandwidth for each PV system to operate. The proposed method enables equal power sharing among multiple PV systems in situations where disconnection of PV systems may be necessary due to the presence of high voltages in the grid in the absence of such a power sharing methodology. Simulation results presented in this paper verify the validity of the developed methodology.

Keywords

sharing, power, radial, systems, pv, photovoltaic, feeder, solar, distribution, multiple, among

Disciplines

Engineering | Science and Technology Studies

Publication Details

B. K. Perera & P. Ciufo, "Power sharing among multiple solar photovoltaic (PV) systems in a radial distribution feeder," in Australian Universities Power Engineering Conference (AUPEC 2013), 2013, pp. 1-6.

Power Sharing among Multiple Solar Photovoltaic (PV) Systems in a Radial Distribution Feeder

Brian K. Perera*, *Student Member, IEEE*, Phil Ciufu, *Senior Member, IEEE* and
 Sarath Perera, *Senior Member, IEEE*
 Australian Power Quality and Reliability Centre,
 School of Electrical, Computer and Telecommunications Engineering,
 University of Wollongong, Australia.
 bkp389@uowmail.edu.au*

Abstract—With an increasing penetration of solar photovoltaic (PV) systems, power distribution grids are becoming more susceptible to network voltage rise. As per applicable standards for grid-connected PV systems, a PV system must be automatically disconnected from the grid when the terminal voltage of the PV system exceeds a defined maximum voltage. With this directive, in certain situations, PV systems connected at nodes at which the voltage sensitivity is high, may be disconnected from the grid while PV systems connected at less sensitive nodes are continuing to operate. In such a situation, owners whose PV systems are connected at nodes at which the voltage sensitivity is high, may lose their revenue. In order to minimise such a disadvantage, the current research proposes a power sharing methodology for PV systems that are connected to a radial distribution feeder by allocating a grid voltage bandwidth for each PV system to operate. The proposed method enables equal power sharing among multiple PV systems in situations where disconnection of PV systems may be necessary due to the presence of high voltages in the grid in the absence of such a power sharing methodology. Simulation results presented in this paper verifies the validity of the developed methodology.

Index Terms—Photovoltaic systems, power sharing, voltage control, voltage sensitivity, voltage source converter.

I. INTRODUCTION

In a distribution grid to which multiple solar photovoltaic (PV) systems are integrated, voltage rise has been identified as a critical technical matter that should be addressed [1]–[3]. In such a grid, voltage may rise to considerably higher levels, especially during the day when power generation from PV systems is at the highest level and load on the grid is at a minimum. The standards applicable to grid-integrated PV systems impose a maximum voltage below which PV systems may stay connected to the grid. The Australian standard that is applicable to grid-integrated PV systems is AS4777.2 [4]. As per [4], the highest grid voltage that PV systems may stay connected is $230\text{ V} + 10\%$ (herein after referred to as U_{\max}). If the point of common coupling voltage (PCC) of a PV system exceeds U_{\max} , after a defined time period the PV system should be disconnected from the grid causing a loss of potential revenue to the owner of the PV system.

When a certain amount of active and reactive power is injected to the grid by a PV system the PCC voltage of the

PV system is a function of the voltage sensitivity at the PCC. Further, the voltage sensitivity at the PCC of a PV system is a function of the grid impedance seen by the PV system at the PCC. Therefore, in certain operating situations, the voltage at the PCC of a PV system where voltage sensitivity is high may reach U_{\max} while the PCC voltages of other PV systems connected to the grid are below U_{\max} . In such a situation the PV system that is connected to the grid at a node where voltage sensitivity is high may disconnect in order to comply to AS477.2 [4] while other PV systems will continue to operate. The discussed scenario highlights that in certain operating situations, owners of PV systems whose PV systems are integrated to the grid at nodes where voltage sensitivity is high are disadvantaged over the other PV system owners whose PV systems are connected to the grid at nodes where voltage sensitivity is less.

A droop based active power sharing methodology is proposed in [5] for PV systems connected to a radial distribution feeder. Since the droop coefficients derived in [5] are based on the voltage sensitivity, the proposed method in [5] can be applied to minimise the disadvantages that PV system owners may experience as a result of their PV systems being connected to nodes where voltage sensitivity is high. An alternative power sharing methodology is proposed in the current research for PV systems that are integrated to a radial distribution feeder. In the power sharing method proposed in the current research, a voltage bandwidth is determined for each PV system connected to a radial distribution feeder. Since the voltage bandwidth is determined based on the voltage sensitivity, power sharing among PV systems connected to the radial distribution feeder is achieved. In the proposed method, closed-loop PCC voltage controllers are used to ensure that PCC voltage of each PV system is maintained within the allocated bandwidth while sharing active power. Further, the use of closed-loop PCC voltage controllers in PV systems guarantee that the voltage of the radial distribution feeder is maintained below U_{\max} .

The organisation of this paper is as follows. In Section II the network that is considered in order to develop the power sharing methodology is illustrated and in Section III the voltage rise issue as a result of integrating PV systems to the grid is introduced. The active power sharing methodology is developed in Section IV and Section VI and simulation

This work is supported by the Australian Research Council (ARC) and Essential Energy Linkage Grant LP100100618.

results are presented in Section V and Section VII. Further improvements to the developed power sharing methodology are suggested in Section VIII followed by conclusions.

II. NETWORK MODEL

A single-phase power distribution feeder to which five PV systems are connected is considered in order to develop the power sharing methodology proposed in the current research. The model of the distribution feeder is shown in Fig. 1. The power grid is modelled as an equivalent Thévenin voltage source with an rms voltage $V_s = 240$ V. The impedances of high and medium voltage power lines and transformers are assumed negligible compared to that of the distribution feeder. Hence, the equivalent impedance of the grid is the impedance of the distribution transformer. The impedance of the the distribution transformer is 4% and is considered as equally distributed along the distribution feeder. Hence the distribution transformer is not shown in the figure.

The distribution feeder is modelled with five equally spaced line sections. Each line section has a resistance, R , and a reactance, X . The PV systems are assumed as directly connected to the distribution feeder without a service wire. Hence there is no impedance representing the service wire in the model. The reference impedance for low voltage public supply systems that is given in [6] for electrical apparatus testing purposes is considered as the grid impedance seen by the PV system PV₅ located at the end of the distribution feeder. Hence the grid impedance seen by PV₅ is $(0.4 + j0.25) \Omega$.

The distribution feeder is connected with five PV systems that are equally spaced along the feeder. Since the PV systems are equally spaced and the impedance of the distribution transformer is considered equally distributed along the feeder, $R = 0.08 \Omega$ and $X = j0.05 \Omega$. PV systems PV₁ – PV₅ are connected at nodes N_1 – N_5 respectively. Nodes N_1 – N_5 are the points of common coupling (PCC) of the PV systems. The rated capacity of each PV array is 5 kW. The PV systems are integrated to the grid via voltage source converters (VSC). The rated capacity of each VSC is 5.4 kVA. Controllers that are able to regulate the PCC voltage of each PV system by dynamically controlling the active and reactive power response of the PV system are implemented in the control system of each PV system. All the PV systems have similar operating and control capabilities. The power sharing methodology proposed in this paper is enabled when power generation from PV systems are high and the load on the distribution feeder is comparatively low. Therefore a zero load condition is assumed in the grid while developing the power sharing methodology.

III. STEADY-STATE VOLTAGE RISE WITH PV

A PV system that is connected to the distribution feeder model in Fig. 1 is illustrated in Fig. 2. In the simplified model shown in Fig. 2, the grid impedance seen by the PV system at the PCC is Z_T , where $Z_T = R_T + jX_T$. The PV system is injecting P_g and Q_g amounts of active and reactive power to the grid respectively and the resulting rms voltage and current at the PCC are V_g and I_g respectively.

A simplified expression for the steady-state voltage rise at the PCC if the PV system is injecting P_g and Q_g amounts of active power and reactive power to the grid respectively can be derived as given in (1) [5].

$$V_g - V_s = \frac{P_g R_T + Q_g X_T}{V_g}. \quad (1)$$

In (1), $V_g - V_s$ is the steady-state voltage rise. As per (1), the voltage at the PCC is increased if active power is injected to the grid by the PV system and if reactive power is absorbed by the PV system, the PCC voltage can be decreased.

IV. DETERMINING A REFERENCE PCC VOLTAGE FOR EACH PV SYSTEM TO SHARE ACTIVE POWER

The reference PCC voltage of each PV system determines the setting above which the dynamic PCC voltage controllers are activated. The reference PCC voltage for each PV system is determined initially in such a way that if power curtailing is required to keep the network voltage within limits, once power curtailing is done to bring the network voltage within limits, each PV system is injecting an equal amount of power to the grid irrespective of the point of connection of each PV system. In this section the methodology that is used to determine the reference PCC voltage of each PV system is described in detail with reference to the network model shown in Fig. 1.

In the network model shown in Fig. 1, the voltage rise at each node with respect to the immediately following node towards the grid can be found by using (1) at the steady-state. Equation (1) is written as in (2) with different notations. In (2), V_n is the voltage at the node N_n ($n = 1, 2, \dots, 5$) that is of interest to determine the steady-state voltage rise, V_{n-1} is the voltage at the node N_{n-1} , P_n and Q_n are the total active and reactive power that flows to the grid through the node N_n respectively, and R and X are the resistance and the reactance of the line section $N_n - N_{n-1}$.

$$V_n - V_{n-1} = \frac{P_n R + Q_n X}{V_n} \quad (2)$$

In order to find the steady-state voltage rise at the node N_n ($n = 1, 2, \dots, 5$) with respect to node N_{n-1} by using (2) the voltage at the node N_{n-1} and the power flow through the node N_n is known. Since the voltage at a node is a function of the active and reactive power injected by the PV system connected at that particular node as well as by other PV systems connected to the feeder, only by an iterative process can the voltage at each node be found. The iterative method that is used to determine the reference PCC voltage of each PV system is described here.

The active power injected by each PV system is assumed equal in a iteration. The reactive power absorbed by each PV system is zero in all iterations. The network losses are disregarded. Since network losses are disregarded and a no-load condition is assumed, the active power that flows through a node is the summation of the active power injected by the PV system connected to the particular node and active power injected by all other PV systems that are connected to the distribution feeder downstream of the node of interest. If the

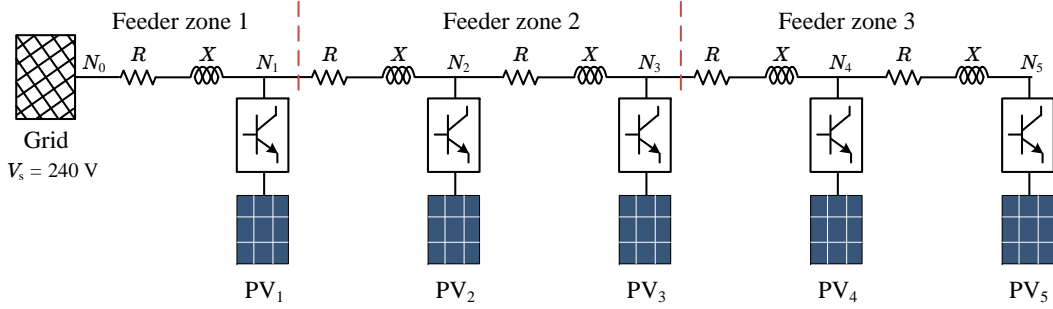

Fig. 1. Network model.

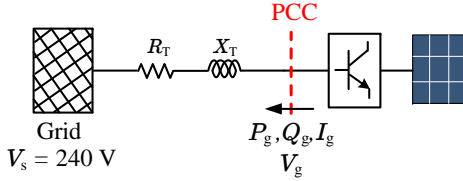

Fig. 2. A simplified model of the network model with one PV system

active power injected by each PV system is P then the active power flows to the grid at node N_n is $(6-n)P$ since the total number of PV systems in the network model in Fig. 1 is five.

The voltage at the node N_n when the active power flowing through the node to the grid is P and the reactive power flowing through the node is zero, can be found by solving (2) for V_n as given in (3).

$$V_n = \frac{V_{n-1} + \sqrt{V_{n-1}^2 + 4(6-n)PR}}{2} \quad (n=1,2,\dots,5) \quad (3)$$

The active power injected by each PV system is set at the beginning of a iteration. Since the voltage at the node N_0 is 240 V, voltages at following nodes can be found by (3) when the power injected by each PV system is known. Since the voltage sensitivity of the node N_5 in the network model is higher than all the other nodes, the voltage at N_5 reaches the maximum voltage limit, U_{\max} , first. Therefore, after finding voltages at all the nodes in an iteration, the voltage at node N_5 , V_5 , is compared to U_{\max} . If $V_5 \leq U_{\max}$ then node voltages calculated in the current iteration are stored, the active power injected by each PV system that is set at the beginning of the current iteration is incremented and the next iteration is started. If $V_5 > U_{\max}$, the node voltages calculated at the previous iteration are considered as the reference PCC voltage of the respective PV system.

The reference PCC voltages that are calculated by the described iterative process for the network model shown in Fig. 1 are given in Table I. According to the results obtained by the iterative method, each PV system should be injecting 2.69 kW of active power to the grid if the respective PCC voltage is regulated by curtailing active power at the reference PCC voltage given in Table I.

TABLE I
REFERENCE PCC VOLTAGES FOR PV SYSTEMS TO SHARE ACTIVE POWER

PV system (PV_n)	Reference PCC voltage (V)
PV_1	244.4
PV_2	247.8
PV_3	250.4
PV_4	252.1
PV_5	253.0

V. SIMULATION RESULTS - PART A

The network model shown in Fig. 1 was modelled in PSCAD/EMTDC simulation program. Each PV system was modelled as presented in [7]. Furthermore, a dynamic PCC voltage controller that is able to regulate the PCC voltage of a PV system by controlling active power response of the PV system was integrated to the model of the PV system. The reference voltage of the PCC voltage controller in each respective PV system was set as given in Table I. The solar irradiance level at each PV system was 1200 W/m² and the surface temperature of all the PV arrays were considered constant at 30 °C.

At the beginning of the simulation, all the PV systems were operating at the maximum power point and the PCC voltage controllers were inactive. At time $t = 1$ s, PCC voltage controllers were activated in all PV systems. The simulation was run for 20 s. The voltage variations at all five nodes that are connected with PV systems and the active power variation at each PV system are illustrated in Fig. 3. As shown in Fig. 3(a), once the controllers were activated, the PCC voltage at each PV system was regulated at the respective reference PCC voltage. The voltage profile of the network is shown in Fig. 4 before and after the PCC voltage controllers were activated.

The amount of active power injected by each PV system before controllers were activated and after power was curtailed to regulate the respective PCC voltage is shown in Fig. 5. Initially each PV system was injecting about 4.85 kW of active power to the grid. Once active power was curtailed to regulate the PCC voltage and controllers reached steady-state, each of the PV systems was injecting about 2.69 kW of active power to the grid. This is the expected amount of active power injection by each PV system if the respective PCC voltage is regulated at the reference voltage given in Table I. As per Fig. 5 there

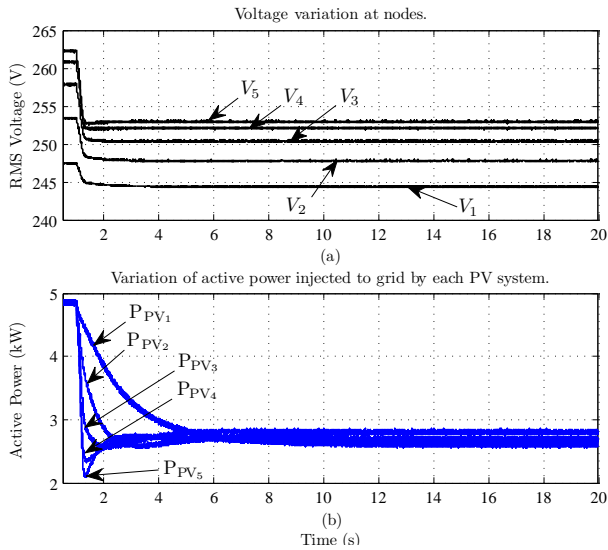

Fig. 3. Simulation results - Part A - PCC voltage and active power variation of the PV systems.

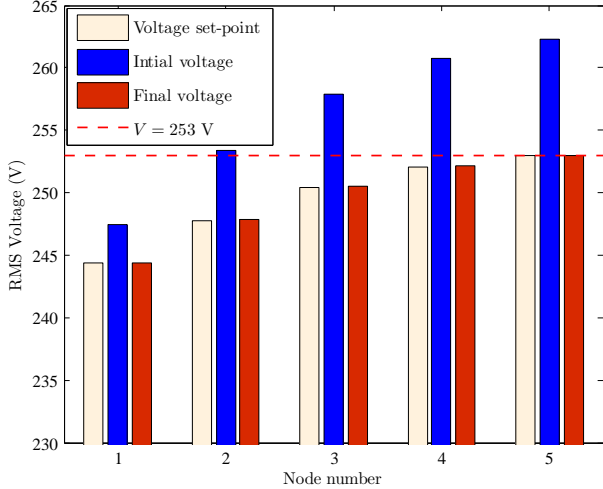

Fig. 4. Simulation results - Part A - Voltage profile of the network.

are slight deviations of the amount of active power injected to the grid by each PV system from the value 2.69 kW after active power was curtailed. These deviations are due to the use of (2) that is simplified based on assumptions, to find the reference PCC voltage of each PV system.

VI. ACTIVE POWER SHARING AMONG PV SYSTEMS WITH REACTIVE POWER CAPABILITIES

PV systems can be built with reactive power capabilities. In such a PV system, the PCC voltage can be dynamically regulated by controlling the reactive power response of the PV system [8] and active power curtailment that may be necessary to regulate the PCC voltage of a PV system can be minimised. The control system of a PV system can be configured to regulate the PCC voltage with reactive power initially if PCC voltage regulation is activated. Then if the amount of reactive power absorbed by the PV system has reached a set limit, active power curtailment can be enabled.

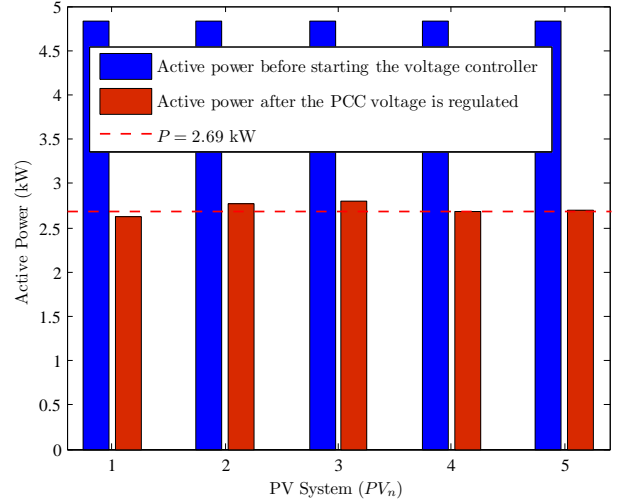

Fig. 5. Simulation results - Part A - Active power injected by each PV system.

$$V_n = \frac{V_{n-1} + \sqrt{V_{n-1}^2 + 4(6-n)(PR + QX)}}{2} \quad (n=1,2,\dots,5) \quad (4)$$

The iterative method that is described in Section IV can be modified to include the reactive power capabilities of PV systems to determine the reference PCC voltages for PV systems. The modified version of (3) in which reactive power capabilities of PV systems are incorporated is given in (4). In the equation, Q is the reactive power injected by each PV system. Since reactive power capabilities of all the PV systems shown in Fig. 1 are similar, the reference PCC voltages calculated by using (4) are the same as that are given in Table I. If each PV system is limited to 0.9 lagging power factor operation and power curtailment is necessary to regulate the PCC voltage of each PV system at the respective reference voltage given in Table I, the maximum active power injected by each PV system should be 3.86 kW.

VII. SIMULATION RESULTS - PART B

In the simulation model of the network shown in Fig. 1, the dynamic PCC voltage controllers that regulate the PCC voltage by controlling the reactive power response of the PV system are implemented in each PV system. The control system of each PV system is configured to utilise the reactive power capabilities of each PV system initially if PCC voltage regulation is necessary. The minimum lagging power factor of each PV system is set as 0.9. Once a PV system reaches the maximum reactive power limit, the respective controller is saturated and active power curtailment is enabled to regulate the PCC voltage. The minimum lagging power factor of a PV system is still maintained when power is curtailed to regulate the PCC voltage.

In order to demonstrate the robustness of the power sharing methodology presented in the current research, variations of solar irradiance were applied to the simulation model. The considered variation of solar irradiance at each PV system is

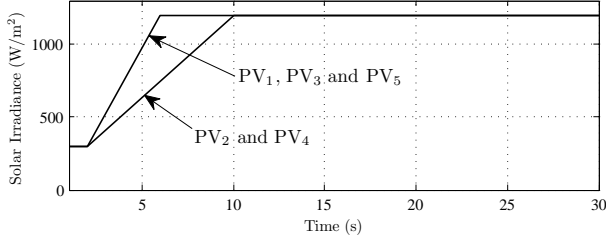

Fig. 6. Variation of solar irradiance.

illustrated in Fig. 6 and respective dynamic variations of PCC voltage, active and reactive power are shown in Fig. 7. The latter figure illustrates that PCC voltage regulation in each PV system is initially achieved by absorbing reactive power from the grid. Once the reactive power limit of each PV system is reached, active power has been curtailed to regulate the PCC voltage. As per Fig. 8 that demonstrates the steady-state voltage profile of the network after solar irradiance has been stabilised, the respective PCC voltage has been regulated at the respective reference voltage. The steady-state active and reactive power injection by each PV system after solar irradiance was stabilised is illustrated in Fig. 9 and Fig. 10 respectively. As shown Fig. 9, each PV system was injecting about 3.86 kW of active power to the grid after active power was curtailed. The reactive power absorbed by each PV system has been limited to 0.9 lagging power factor operation of the PV system as illustrated in Fig. 10. Simulation results presented in this section demonstrate that by operating each PV system of the network at the respective reference PCC voltage given in Table I, active power sharing can be achieved in the network shown in Fig. 1.

VIII. DISCUSSION

The power sharing methodology proposed in the current research is successfully applied to the network shown in Fig. 1. There are minor deviations in the amount of active power shared among PV systems from what is expected as shown in Fig. 5 and Fig. 9. These deviations are mainly due to the use of (3) or (4) that are simplified, based on assumptions to determine the reference PCC voltages for each PV system as given in Table I. The mentioned deviations in active power shared by each PV system can be further minimised if reference PCC voltages are determined through a detailed load flow analysis of the network shown in Fig. 1.

In the network model shown in Fig. 1, upstream impedances are disregarded and the impedance of the distribution transformer is assumed as equally distributed along the distribution feeder. However, in a practical situation, there are upstream impedances and the impedance of the distribution transformer is not distributed along the distribution feeder. Although the above assumption is a significant deviation from an actual situation, that assumption does not cause any inaccuracy to the developed power sharing methodology if that is implemented in a actual power system. This is because in an actual power system, the upstream or downstream power flow through the distribution transformer causes the voltage shift in the whole distribution feeder equally.

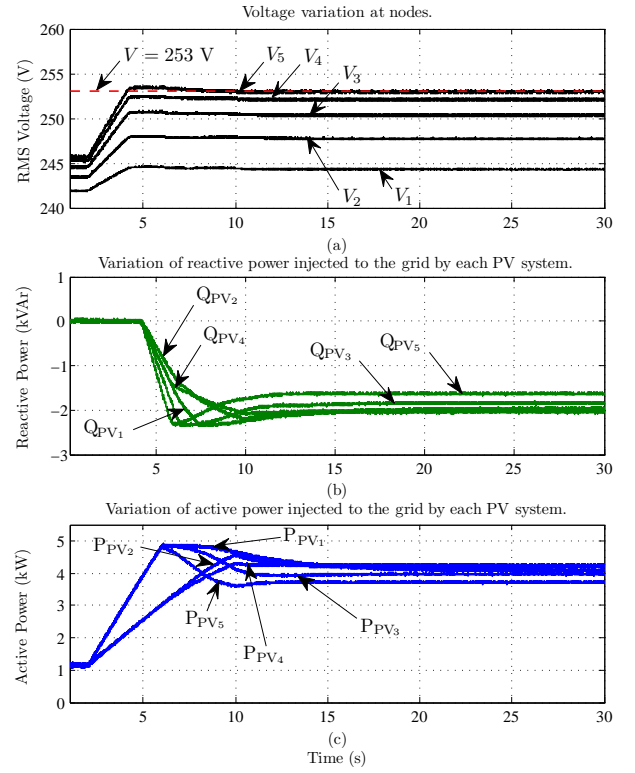

Fig. 7. Simulation results - Part B - PCC voltage and active and reactive power variation of PV systems.

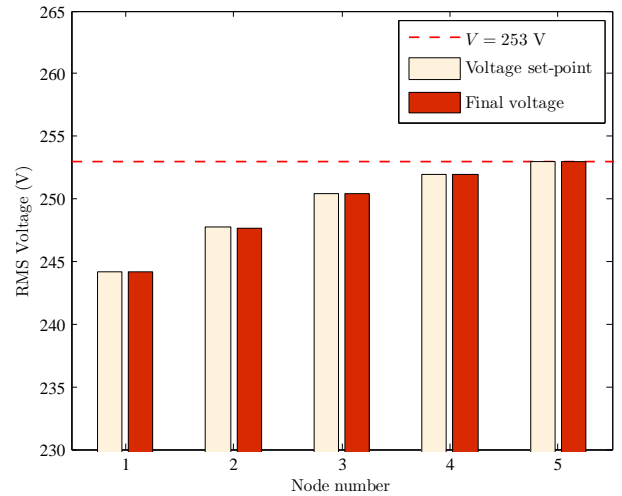

Fig. 8. Simulation results - Part B - Voltage profile of the network.

The reference PCC voltages given in Table I are applicable only to the network shown in Fig. 1. If an additional PV system is integrated to the network, reference PCC voltages should be recalculated to suit the new network. If the developed power sharing methodology is practically implemented in a radial distribution feeder, since PV systems are being integrated to the grid continuously, there will be a need to change the reference PCC voltage of each PV system connected to the considered feeder when an additional PV system is integrated. Further, in the network model shown in Fig. 1, the impedances of service wires are disregarded. In a practical application,

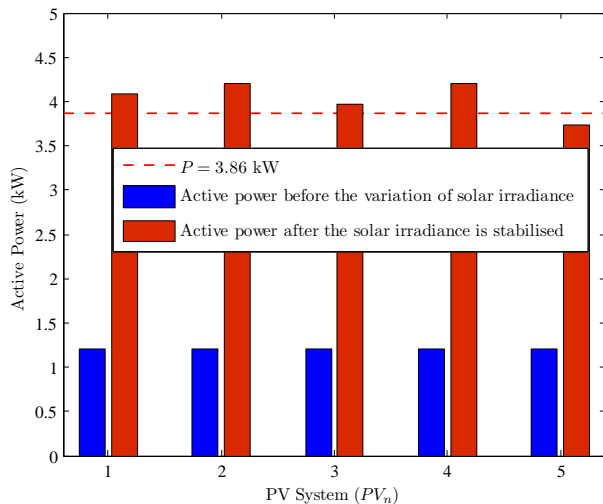

Fig. 9. Simulation results - Part B - Active power injected by each PV system.

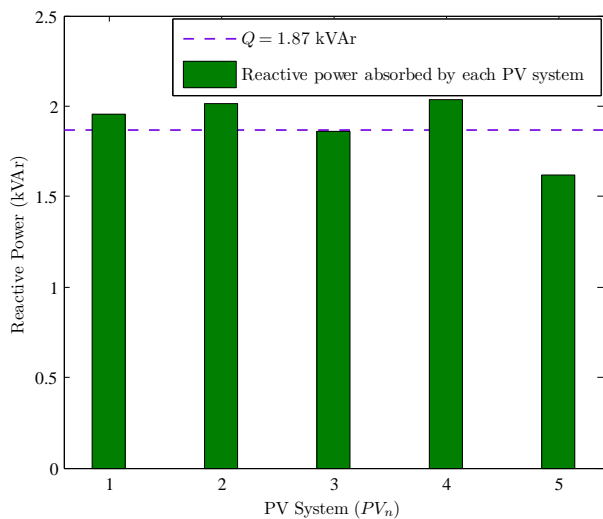

Fig. 10. Simulation results - Part B - Reactive power absorbed by each PV system.

where impedances of service wires should be accounted for, the developed power sharing methodology may not be that accurate. Therefore in order to enhance the practical application and accuracy, the developed power sharing methodology should be further improved.

IX. CONCLUSIONS

A power sharing methodology for PV systems that are integrated to a radial distribution feeder is proposed in the current research. The developed methodology determines a voltage bandwidth for each PV system to operate. The allocated voltage bandwidth of each PV system is proportional to the voltage sensitivity at the PCC of the PV system. The determined voltage bandwidth of each PV system ensures equal power sharing among PV systems if power curtailing is necessary to keep the operation of the PV system within the voltage bandwidth. Thereby, disadvantages associated with the voltage sensitivity at the point of connection of the PV

system that an owner of a grid-integrated PV system may experience are minimised. In the developed power sharing method, the allocated bandwidth for each PV system is a function of the number of PV systems integrated to the distribution feeder. Since PV systems are continuously being integrated, the allocated bandwidth for each PV system should be changed when an additional PV system is integrated to the feeder. In order to minimise such practical difficulties the work presented in the current research should be further improved.

REFERENCES

- [1] T. Stetz, W. Yan, and M. Braun, "Voltage control in distribution systems with high level PV-penetration -improving absorption capacity for PV systems by reactive power supply," in *Proc. 25th European Photovoltaic Solar Energy Conf. and Exhibition*, Sep. 2010, pp. 5000–5006.
- [2] E. Demirok *et al.*, "Local reactive power control methods for overvoltage prevention of distributed solar inverters in low-voltage grids," *IEEE Trans. Photovoltaics*, vol. 1, no. 2, pp. 174–182, Oct. 2011.
- [3] T. Stetz, F. Marten, and M. Braun, "Improved low voltage grid-integration of photovoltaic systems in Germany," vol. 4, no. 2, pp. 534–542, Apr. 2013.
- [4] *Grid Connection of Energy Systems via Inverters - Part 2: Inverter Requirements*, Australian Std. AS4777.2, 2005.
- [5] R. Tonkoski, L. A. C. Lopes, and T. H. M. El-Fouly, "Coordinated active power curtailment of grid connected PV inverters for overvoltage prevention," vol. 2, no. 2, pp. 139–147, Apr. 2011.
- [6] "Electromagnetic Compatibility (EMC) - Consideration of reference impedance and public supply network impedances for use in determining disturbances characteristics of electrical equipment having a rated current ≤ 75 A per phase," IEC, Tech. Rep. TR 60725, Jun. 2012.
- [7] B. K. Perera, S. R. Pulikanti, P. Ciufu, and S. Perera, "Simulation model of a grid-connected single-phase photovoltaic system in PSCAD/EMTDC," in *Proc. IEEE Int. Conf. on Power System Technology (POWERCON)*, Oct. 2012, pp. 1–6.
- [8] B. K. Perera, P. Ciufu, and S. Perera, "Point of common coupling (PCC) voltage control of a grid-connected solar photovoltaic system," unpublished, accepted for presentation at the 39th Annual Conf. of the IEEE Industrial Electronics Society (IECON'13), Vienna, Austria, 2013.