



UNIVERSITY  
OF WOLLONGONG  
AUSTRALIA

University of Wollongong  
Research Online

---

Faculty of Engineering - Papers (Archive)

Faculty of Engineering and Information Sciences

---

2001

# Mechanism for Unstable Pneumatic Conveying of Granular Materials through Horizontal Pipe

J Yi

Peter W. Wypych

*University of Wollongong*, peter\_wypych@uow.edu.au

David B. Hastie

*University of Wollongong*, dhastie@uow.edu.au

<http://ro.uow.edu.au/engpapers/1283>

---

## Publication Details

Yi, J, Wypych, PW & Hastie, DB, Mechanism for Unstable Pneumatic Conveying of Granular Materials through Horizontal Pipe, Bulk Materials Storage, Handling and Transportation Conference Proceedings Vol 2, 2001, p 907-915, Canberra, Australia: The Institution of Engineers, Australia.

Research Online is the open access institutional repository for the University of Wollongong. For further information contact the UOW Library:  
research-pubs@uow.edu.au

# Mechanism for Unstable Pneumatic Conveying of Granular Materials through Horizontal Pipe

**J Yi, PW Wypych and DB Hastie**

Centre for Bulk Solids and Particulate Technologies  
Faculty of Engineering, University of Wollongong  
Northfields Avenue, Wollongong NSW 2522, Australia

**Summary** Since the pneumatic conveying performance of granular materials in the transition zone between dilute-phase and dense-phase still lacks full understanding and assessment, especially the mechanism for the formation of unstable flow, tests have been carried out on poly pellets (particle diameter = 4.7 mm, particle density = 897 kg/m<sup>3</sup>) and two different stainless steel pipelines (60.3 and 98.4 mm ID, each 21 m long). By careful observation and analysis of flow behaviours (covering dilute-phase, unstable zone and low-velocity slug-flow), five different flow modes (as the air velocity is decreased): fully suspended flow; strand flow; stable or unstable strand flow over a stationary layer for low solid mass flow rates; strand flow over a slowly moving bed for high solid mass flow rates; low-velocity slug-flow are identified. The mechanism involved in the formation of unstable zone was explored.

## 1 NOMENCLATURE

D	pipe diameter, m
$d_p$	particle diameter, m
L	length of a pipeline, m
$m_f$	air mass flow rate, kg s <sup>-1</sup>
$m_s$	product mass flow rate, kg s <sup>-1</sup>
$\rho_b$	bulk density, kg m <sup>-3</sup>
$\rho_p$	particle density, kg m <sup>-3</sup>

## 2 INTRODUCTION

The pneumatic conveying of granular bulk solids is one of the most common and popular methods of material transportation in industry with advantages such as safety, low cost, flexibility of layout, ease of automation, security, low maintenance, ease of installation, hygienic and environmental friendly method of transport [1,2]. The state diagram or conveying characteristics for granular materials shown in Fig. 1 consists of three boundary lines A, B and C and curve D delineating the condition when particles begin to deposit on the bottom of the pipeline [3,4]. So far, there are no design models that can predict all the boundaries reliably, also the formation of the unstable zone located between Lines B and C in the state diagram is still lacking understanding and appreciation.

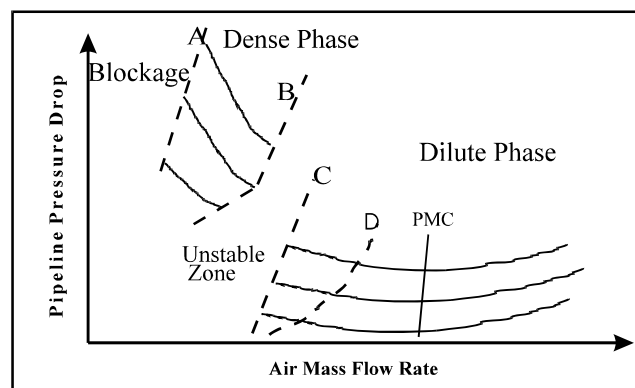

Figure 1 Conveying characteristics of pneumatic conveying of granular materials

Exploring the mechanism involved in the formation of unstable zone will help to explain and understand the pressure fluctuations and possible pipeline blockages that can occur in the unstable zone and provide an approach to predict its boundaries. In this paper, the mechanism for the formation of the unstable zone is investigated experimentally by careful observation and analysis of flow behaviour, pressure drop across the conveying pipeline and solids retained in the pipeline (covering dilute-phase, unstable zone and low-velocity slug-flow).

### 3 EXPERIMENTAL RIG

The pneumatic conveying test rig was designed and established for the purpose of testing air-solid two-phase flow activities of granular particles covering both the dense-phase and dilute-phase regimes. It provides visual observation and all the necessary operating information, such as pressure drop, solid mass flow rate, air mass flow rate and particles retained in the pipeline. A schematic layout of the test rig is shown in Figure 2.

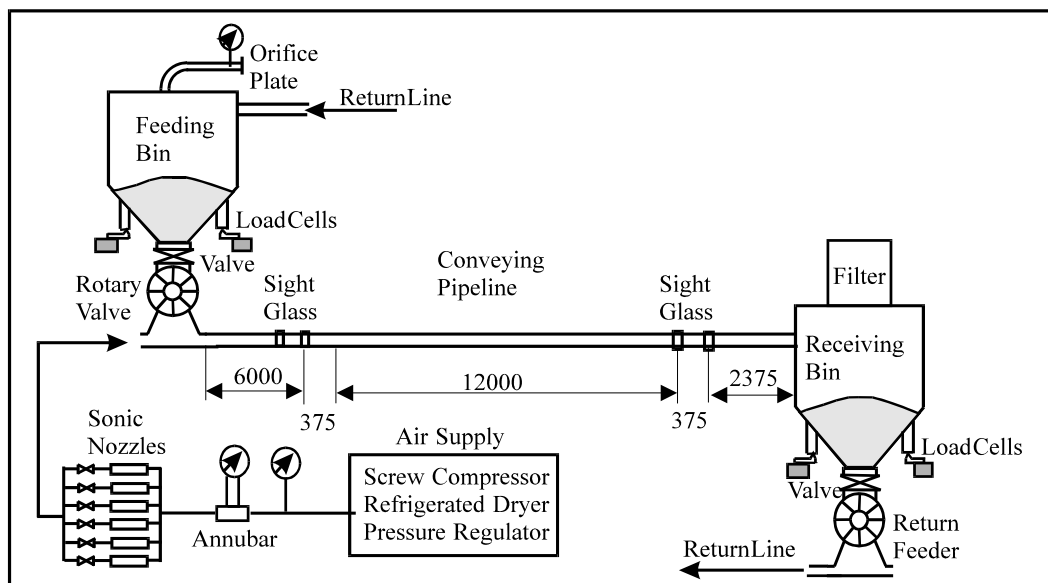

Figure 2 Configuration of test rig

### 4 EXPERIMENTAL RESULTS FOR LOW SOLIDS MASS FLOW RATE

For a low solids mass flow rate of about 0.37 kg/s and a decreasing air mass flow rate, the following flow phenomena were observed through the sight-glass 6.0 m from the feeding point, and corresponding pressure drop across the pipeline and solids retained in it also were measured.

#### 4.1 Suspension and/or Strand Flow for Low Solids Mass Flow Rate

Figure 3 shows the pressure drop across the pipeline and solids retained in it for terminal air velocities (air velocity at the end of the conveying pipeline) of 19.9 m/s, 12.8 m/s and 11.4 m/s. The flow phenomena observed through the sight-glass were full suspension, strand flow and pulsating strand flow. Analysis of the pressure drop and solids contained in the pipeline indicates these parameters remain almost constant as the terminal air velocity decreases from 19.9 m/s to 12.8 m/s. When the terminal air velocity further decreases to 11.4 m/s, a pronounced increase in pressure drop across the pipeline and solids contained in it reveals that the flow structure of the air-solid two-phase flow tends to change from the inlet of the pipeline line. The operations represented by the three curves in Figure 3 should be located in the area to the right of Line D in the PCC shown in Figure 1.

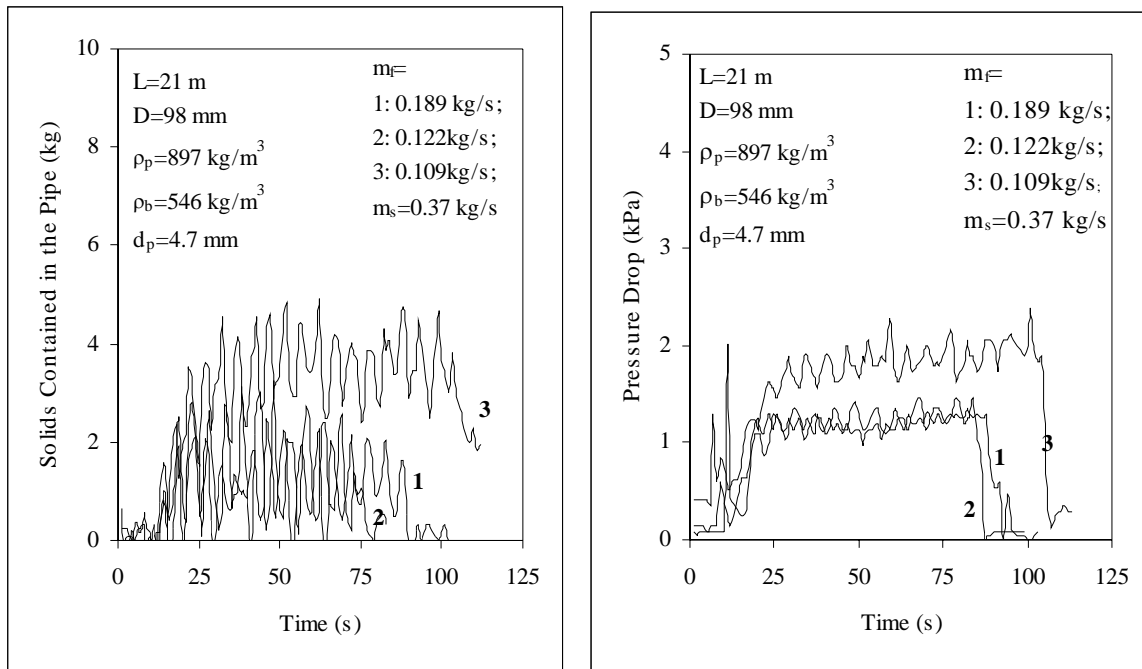

Figure3 Solids contained in pipeline and the pressure drop across it for strand flow (low solids mass flow rate)

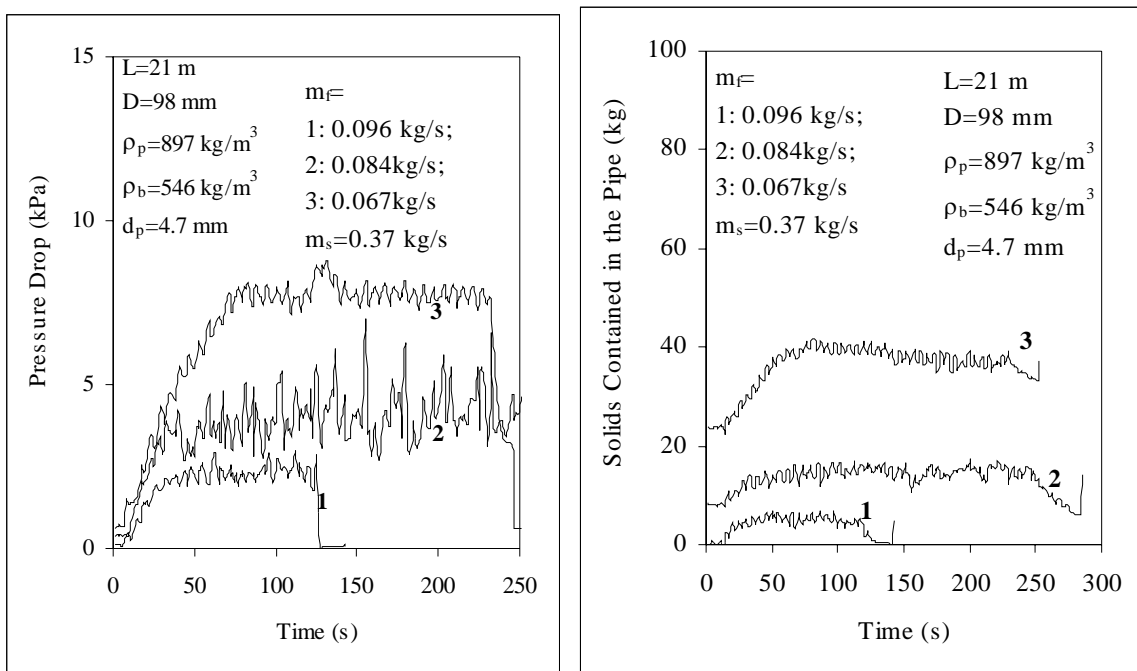

Figure4 Solids contained in pipeline and the pressure drop across it for strand flow over stationary layer (low solids mass flow rate)

#### 4.2 Strand Flow over a Stationary Layer for Low Solids Mass Flow Rate

Figure 4 shows the pressure drop across the pipeline and solids contained in it for terminal air velocities of 10.2 m/s, 8.9 m/s and 7.0 m/s. The flows observed through the sight-glass were a thick strand flow, strand flow over a stationary layer about 20 mm in thickness and strand flow over a stationary layer about 30 mm in thickness. During the conveying tests, an extension and thickening of the stationary layers also were observed. The curves representing the pressure drop and solids contained in the pipeline in Figure 4 show that these parameters both increase corresponding to the extension and thickening of the stationary layers in the conveying pipeline. The

operations represented by the three curves in Figure 4 should be located in the area between Line D and C in the PCC shown in Figure 1.

#### 4.3 Flow Mode of Unstable Flow for Low Solids Mass Flow Rate

Figure 5 shows the pressure drop across the pipeline and solid retained in it for terminal air velocities of 5.2 m/s and 3.4 m/s. Observations through the sight-glass showed that air-solid two-phase flow begins as a strand over a thickening and extending stationary layer, then a slug is formed at the inlet of the conveying pipeline and moves quickly towards the receiving bin picking up the thick layer of material in front of it, depositing a thin layer behind it and becoming longer and violent until it enters the receiving bin. After that, the air-solid two-phase flow repeats the process of building up a thick stationary layer along the conveying pipeline and forming a slug to sweep the layer into the receiving bin. The curves representing the pressure drop and solids contained in the pipeline in Figure 5 show that these parameters increase gradually corresponding to the extension and thickening of the stationary layers in the conveying pipeline. The sudden increase in the pressure drop reveals the formation of a slug and its lengthening. The quick decreases in pressure drop across the conveying pipeline and the solids retained in the pipeline indicate the slug entering the receiving bin. In Figure 5 it is also shown that the higher the amount of the solids retained in the pipeline, the higher the peak pressure drop across the pipeline. Analysis of the pressure drop across the pipeline, solids retained in it and the observations through the sight-glass confirms that the flow alternates between the mode of a strand over a stationary layer and a violent slug flow. Also, the pressure fluctuations within the unstable zone result from the flow mode transition from strand flow over a stationary layer to slug flow starting at the inlet due to a decrease in air velocity (due to increase in pressure drop and air density). The operations represented by the two curves in Figure 5 should be located in the area between Line B and C in the PCC shown in Figure 1.

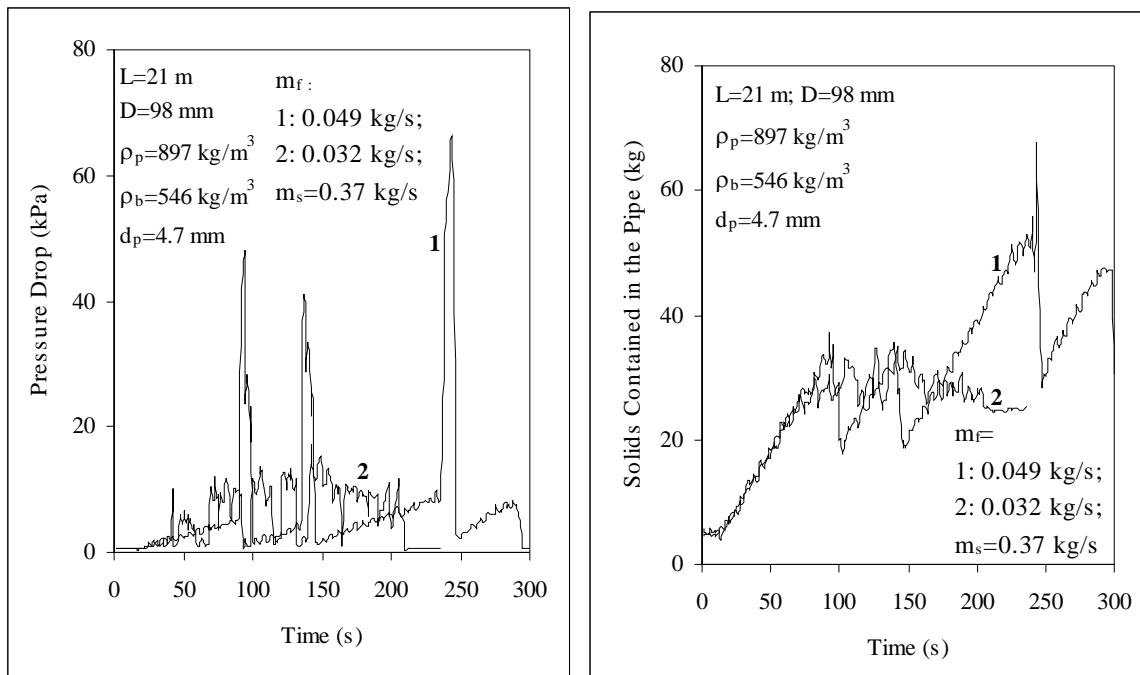

Figure 5 Solids contained in pipeline and the pressure drop across it for unstable flow (low solids mass flow rate)

#### 4.4 Low-Velocity Slug-Flow for Low Solids Mass Flow Rate

Figure 6 shows the pressure drop across the pipeline and solids contained in it for terminal air velocities of 2.1 m/s, 1.6 m/s and 1.1 m/s. The flow phenomena observed through the sight-glass involved stable low-velocity slug-flow with stationary layers of about 35 mm, 50 mm and 55 mm thickness respectively. Curves 1 and 2 representing the pressure drop and solids contained in the pipeline in Figure 6 show that these parameters increase corresponding to a thickening of the stationary layer between the moving slugs. Curve 3 shows the solids accumulating in the conveying pipeline and the solids mass flow rate can not be maintained at the outlet of the pipeline because of air mass flow rate being too low. The operations represented by the three curves in

Figure 6 should be located in the area between Line B and A in the PCC shown in Figure 1, with Curve 3 close to Line A.

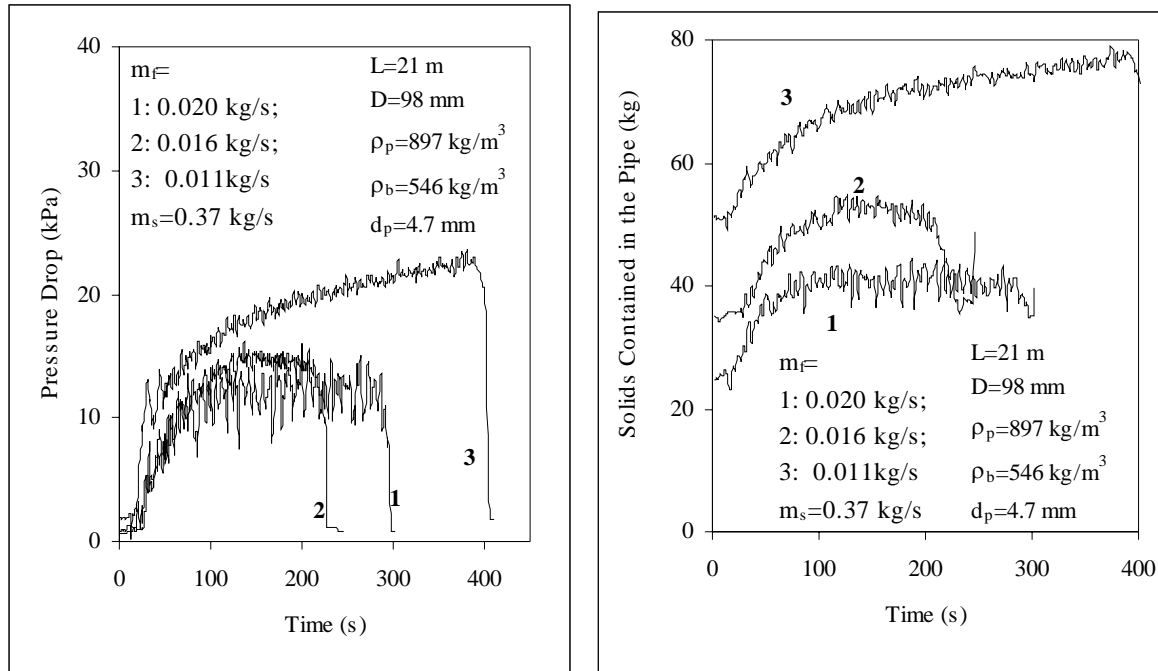

Figure 6 Solids contained in pipeline and the pressure drop across it for slug flow (low solids mass flow rate)

## 5 EXPERIMENTAL RESULTS FOR HIGH SOLIDS MASS FLOW RATE

For a high solids mass flow rate of about 1.8 kg/s and a decreasing air mass flow rate, the following flow phenomena were observed through the sight-glass 6.0 m from the feed point and the pressure drop across the pipeline and solids contained in it also were measured.

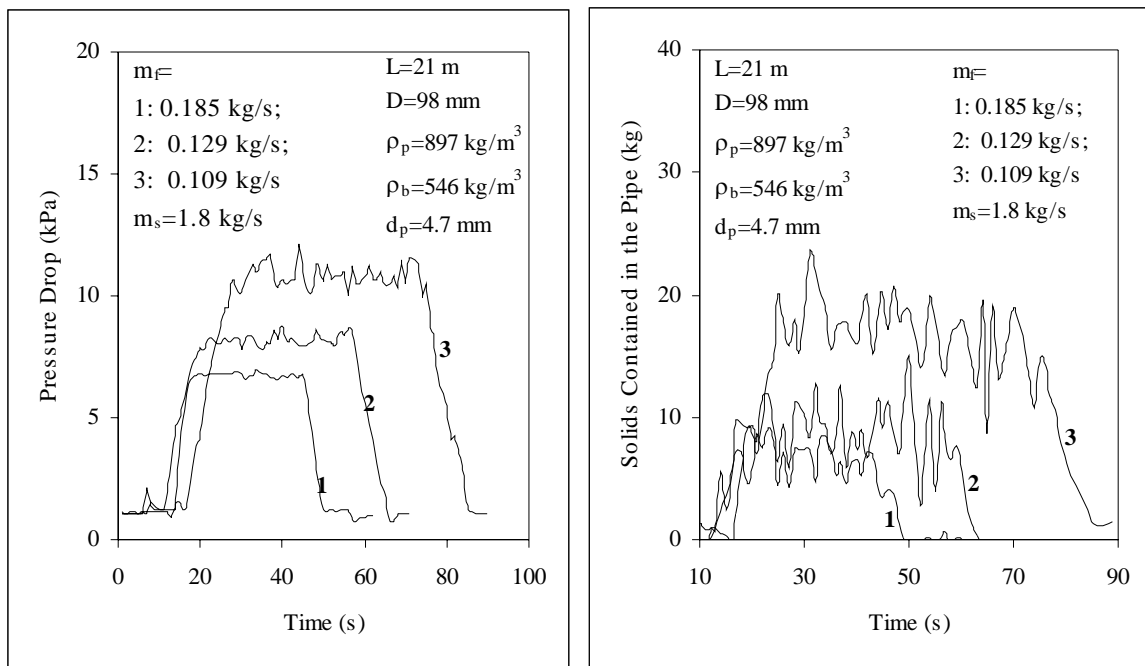

Figure 7 Solids contained in pipeline and pressure drop across it for strand flow (high solids mass flow rate)

### 5.1 Suspension and/or Strand Flow for High Solids Mass Flow Rate

Figure 7 shows the pressure drop across the pipeline and solids contained in it for terminal air velocities of 19.5 m/s, 13.5 m/s and 11.5 m/s. The flow phenomena observed through the sight-glass were fully suspension, strand flow and pulsating strand flow. Analysis of the pressure drop and solids contained in the pipeline indicates that both these parameters slightly increase as the terminal air velocity decreases from 19.5 m/s to 13.5 m/s. When the terminal air velocity is decreased further to 11.5 m/s, a quick increase in pressure drop across the pipeline and solids retained in it reveals that the flow structure of the air-solid two-phase flow tends to change from the inlet of the pipeline line. The operations represented by the three curves in Figure 7 should be located in the area to the right of Line D in the PCC shown in Figure 1.

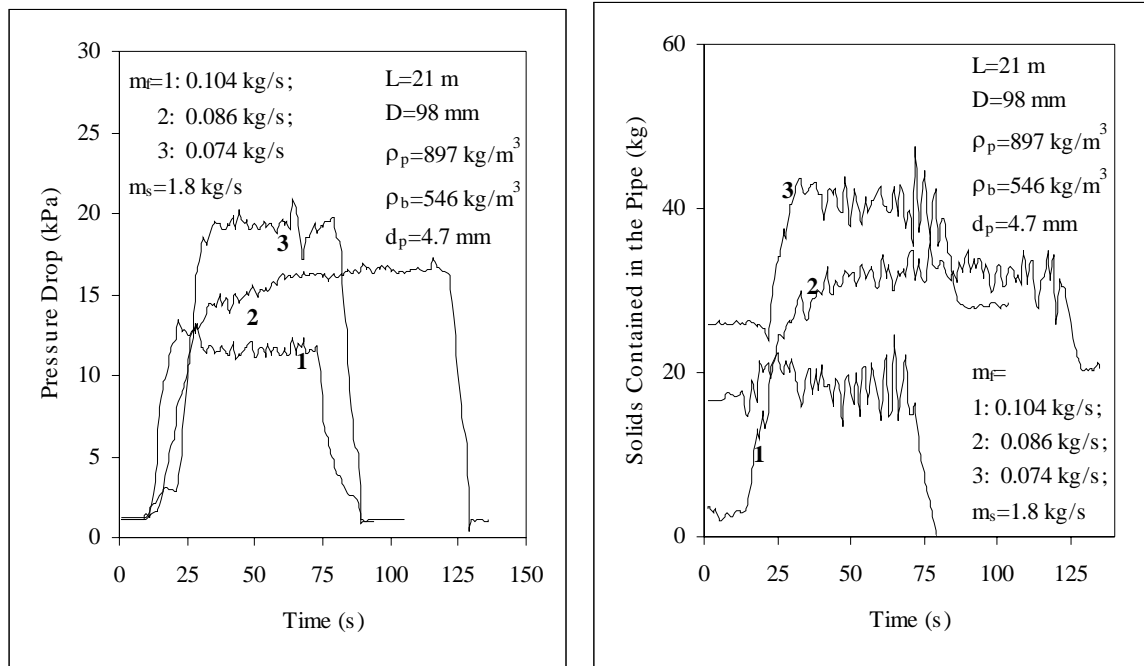

Figure 8 Solids contained in pipeline and pressure drop across it for strand flow over moving layer (high solids mass flow rate)

### 5.2 Strand Flow over Slowly Moving Layer for High Solids Mass Flow Rate

Figure 8 shows the pressure drop across the pipeline and solids contained in it for terminal air velocities of 10.9 m/s, 9.1 m/s and 7.8 m/s. The flow phenomena observed through the sight-glass were strand flow over a slowly moving layers with about 15 mm, 25 mm and 35 mm thickness respectively. During the conveying tests, extension and thickening of the slowly moving layers also were observed. The curves representing the pressure drop across the pipeline and solid contained in it in Figure 8 show that both these parameters increase corresponding to the extension and thickening of the slowly moving layers in the conveying pipeline. The operations represented by the three curves in Figure 8 should be located in the area between Line D and C in the PCC shown in Figure 1.

### 5.3 The Flow Mode of Unstable Flow for High Solids Mass Flow Rate:

Figure 9 shows the pressure drop across the pipeline and solids retained in it for terminal air velocities of 6.6 m/s and 6.3 m/s. Observations through the sight-glass showed that flow begins in the mode of a strand over a thickening and extending slowly moving layer, then a slug is formed at the inlet of the conveying pipeline and is moving quickly towards the receiving bin picking up a thick layer of material in front of it, depositing a thin layer behind it and becoming longer and violent until it enters the receiving bin. This process is repeated until the end of the cycle. The sudden increase in the pressure drop reveals the formation of a slug and its lengthening. The quick decrease in pressure drop across the conveying pipeline and the solids retained in the pipeline indicates the slug(s) entering the receiving bin. The higher amount of solids contained in the pipeline, the higher the peak pressure drop across the pipeline. In contrast to the stationary layer on the bottom of the conveying

pipeline for low solids mass flow rate, the layer on the bottom of the pipeline for high solids mass flow rate is moving slowly (due to the higher solids loading imposing a greater drag force on the lower layer). The operations represented by the two curves in Figure 9 should be located in the area between Line B and C in the PCC shown in Figure 1

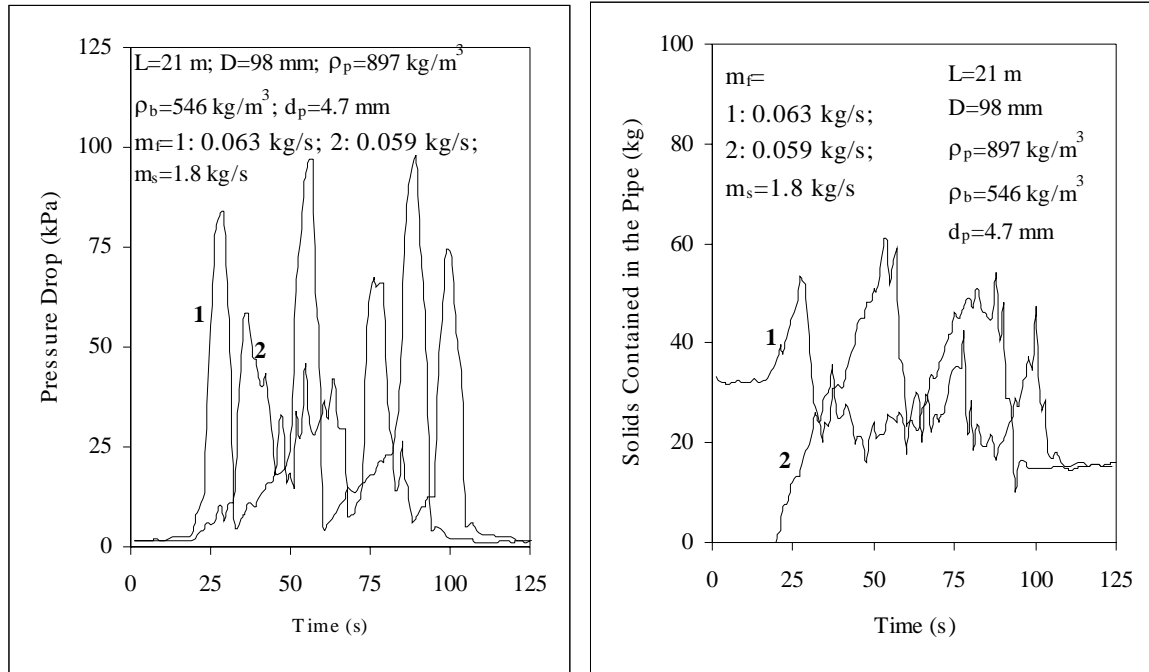

Figure 9 Solids contained in the pipeline and pressure drop across it for unstable flow (high solids mass flow rate)

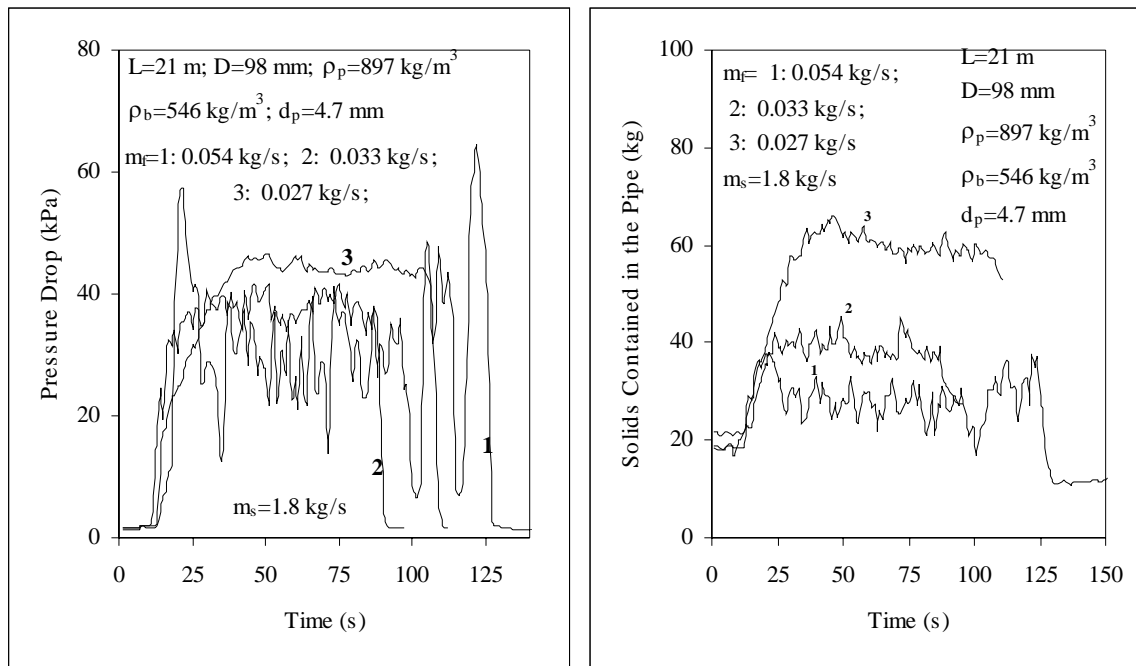

Figure 10 Solids contained in the pipeline and the pressure drop across it for slug-flow (high solids mass flow rate)



## 5.4 The Flow Mode of Low-Velocity Slug-Flow for High Solids Mass Flow Rate

Figure 10 shows the pressure drop across the pipeline and solids retained in the pipeline for terminal air velocities of 5.7 m/s, 3.5 m/s and 2.8 m/s. The flow phenomena observed through the sight-glass were stable low-velocity slug-flow with the thickness of the stationary layers about 10 mm, 20 mm and 30 mm, respectively. Curves 1, 2 and 3 representing the pressure drop and solids retained in the pipeline in Figure 10 show that both these parameters increase corresponding to the thickening of the stationary layers between the moving slugs. Curve 1 shows that low-velocity slug-flow is still not very stable especially during the time between 95 second to 125 second and the air-solid two-phase flow is close to unstable flow. The operations represented by the three curves in Figure 10 should be located in the area between Line B and A in the PCC shown in Figure 1. The various flow modes observed and described in this paper are summarised conveniently in Figure 11.

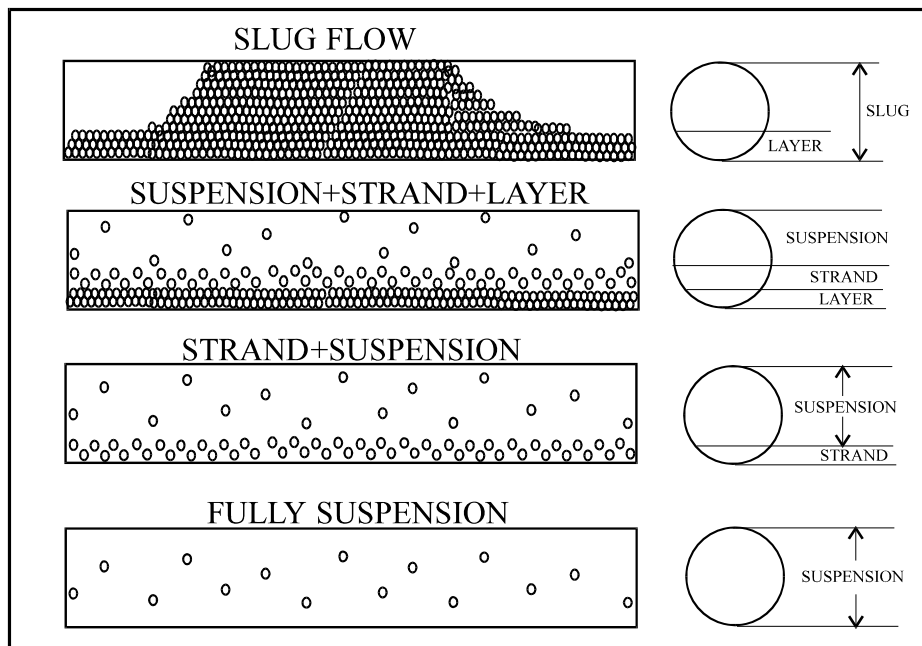

Figure 11 The flow modes for pneumatic conveying of granular materials through a horizontal pipeline

## 6 CONCLUSIONS

Based on conveying tests conducted on a rig with a 98 mm internal diameter stainless steel pipeline 21 m in length, the following conclusions are based on the careful observation and the analysis of pressure drop across the conveying pipeline and solids contained in the pipeline for conveying conditions covering dilute-phase, unstable zone and low-velocity slug flow dense phase:

- Pneumatic conveying of granular solid materials exhibit three different flow modes: low-velocity slug flow, dilute-phase flow with suspended particles and/or strands, strand flow over a stationary layer for low solid mass flow rates and strand flow over a slowly moving bed for high solid mass flow rates.
- Solids mass flow rate has an important influence on the air-solid two-phase flow behaviour when the operation is in or close to the unstable zone. The layers under the strand flow are subjected to different conditions at the bottom of the conveying pipeline: either strand flow over a stationary layer for low solids mass flow rates or strand flow over a slowly moving bed for high solid mass flow rates.
- The pressure fluctuations within the unstable zone result from the flow mode transition from strand flow over a stationary layer (or slowly moving bed) to slug flow starting at the inlet due to a decrease in air velocity. The first slug moves quickly at a relatively high velocity and picks up a relatively thick stationary layer in front of it but only deposits a small amount of the material behind it. The increase in slug length and large increase in pressure cause severe pressure fluctuations and pipeline vibrations.
- In the unstable zone, the time taken to build up the stationary layer or slowly moving bed is reduced as the air mass flow rate approaches the boundary between the unstable and dense-phase operating zones.

- The transition between dilute-phase flow with suspended particles and/or strands and strand flow over a stationary or a slowly moving bed causes a pulsating flow as the results of material eroded away from the end of the stationary layer or slowly moving bed.

## **7. ACKNOWLEDGEMENTS**

The authors would like to acknowledge and thank: IFPRI for the financial support and guidance provided towards this project; the University of Wollongong for the scholarships that allowed this research to be pursued in detail.

## **8. REFERENCES**

- [1] Wypych, PW: Improving Efficiency and Product Quality in Pneumatic Conveying, Australian Bulk Handling Review, Vol. 3, No. 1, 1998, pp 12-15.
- [2] Mills, D: Pneumatic Conveying Design Guide, Butterworths, London, UK, 1990.
- [3] Yi, J and Wypych PW: Modelling the unstable boundary for low-velocity slug-flow conveying, The 3<sup>rd</sup> Israel Conf. For Conveying and Handling of Particulate Solids, 2000, The Dead Sea, Israel, pp 10.11-10.17.
- [4] Yi, J: The Boundaries for Pneumatic Conveying, Ph.D. Thesis, University of Wollongong, 2001(under examination).