

University of Wollongong

## Research Online

---

Faculty of Engineering and Information  
Sciences - Papers: Part A

Faculty of Engineering and Information  
Sciences

---

1-1-2012

### Application of multi-agent system for preventing power interruption in a large power system

S R. Islam

*University of Wollongong, sri703@uowmail.edu.au*

Darmawan Sutanto

*University of Wollongong, soetanto@uow.edu.au*

K M. Muttaqi

*University of Wollongong, kashem@uow.edu.au*

Follow this and additional works at: <https://ro.uow.edu.au/eispapers>



Part of the [Engineering Commons](#), and the [Science and Technology Studies Commons](#)

---

#### Recommended Citation

Islam, S R.; Sutanto, Darmawan; and Muttaqi, K M., "Application of multi-agent system for preventing power interruption in a large power system" (2012). *Faculty of Engineering and Information Sciences - Papers: Part A*. 278.

<https://ro.uow.edu.au/eispapers/278>

Research Online is the open access institutional repository for the University of Wollongong. For further information contact the UOW Library: [research-pubs@uow.edu.au](mailto:research-pubs@uow.edu.au)

---

# Application of multi-agent system for preventing power interruption in a large power system

## Abstract

This paper presents an emergency control approach for preventing wide spread power interruption using multi-agent system. The proposed control algorithm is based on decentralized architecture of intelligent agents to achieve fast and accurate response when a catastrophic disturbance is identified in the system. By dividing the network into several areas, the voltage instability problem can be localized and countermeasures can be directed to the most affected area by the authorized local agent. This facilitates quick decision making within the system. The effectiveness of the proposed technique has been proved by a simulation of IEEE 57 bus test power system.

## Keywords

agent, multi, application, large, power, interruption, preventing, system

## Disciplines

Engineering | Science and Technology Studies

## Publication Details

S. R. Islam, D. Sutanto & K. M. Muttaqi, "Application of multi-agent system for preventing power interruption in a large power system," in Proceedings of International Conference on Harmonics and Quality of Power, ICHQP, 2012, pp. 226-231.

# Application of Multi-agent System for Preventing Power Interruption in a Large Power System

S.R. Islam, D.Sutanto, *Senior Member, IEEE* and K. M. Muttaqi, *Senior Member, IEEE*

**Abstract**— This paper presents an emergency control approach for preventing wide spread power interruption using multi-agent system. The proposed control algorithm is based on decentralized architecture of intelligent agents to achieve fast and accurate response when a catastrophic disturbance is identified in the system. By dividing the network into several areas, the voltage instability problem can be localized and countermeasures can be directed to the most affected area by the authorized local agent. This facilitates quick decision making within the system. The effectiveness of the proposed technique has been proved by a simulation of IEEE 57 bus test power system.

**Index Terms**—Multi-Agent System, Power Interruption, Voltage Collapse, Voltage Stability

## I. INTRODUCTION

With the introduction of interconnected power system, power industries are operating close to their stability limit due to the excessive demand from the consumer side. Power systems become vulnerable to various instability problems such as voltage instability when load increases or any contingency happens during the peak load [1]. The capability of a power system to maintain an acceptable voltage profile, both in normal and emergency situations, has an important effect on the quality of power as voltage instability may lead to power system interruption or even a complete black out. Voltage stability has become a significant issue in determining the maximum power transfer limit.

Voltage instability is the main reason of power interruption in the past several years. Voltage instability due to the cascade of protection maloperation is one of the main reasons for the recent North American power interruption on August 14, 2003 [2]. For this reason, power utilities are devoting a great deal of efforts in solving voltage instability problem.

One of the main quality indicators of electrical energy is continuity of service. This can be harmfully affected when the system is subjected to disturbance like loss of multiple transmission lines or generators. The conventional nose curve (P versus V) analysis shows how the system stability margin is reduced after a contingency occurs, affecting the

ability of power transfer and leading the system to unacceptable levels of voltages.

Severe disturbances on the transmission lines of a large interconnected power system often cause widespread blackouts when thousands of consumers lose power supply costed at millions of dollars loss. The existing protection system is not capable of maintaining the grid integrity during multiple contingencies [5]. Some of the recent blackouts occurred in highly loaded interconnected power systems due to EHV line interruption followed by multiple contingencies [6]. The July 2, 1996 black out in United States was a result of several transmission line outages [4].

The phenomenon of voltage collapse is often caused by an initial low voltage profile due to the failure to supply sufficient reactive power to the loads. The voltage instability is a dynamic phenomenon characterized by a first deceptive stable phase, lasting up to one or two minutes and then a sharp gradual reduction in the transmission voltage resulting in a voltage collapse [1]. The first deceptive calm phase is due to the field forcing of the rotating units until the field current is reduced by rotor protection. The voltage reduction caused by the disturbance initiates automatic tap changing in the load substation and the uncoordinated actions of the tap changing transformers are the main reasons of the system dynamic changes in the first stable phase. After the thermal limit has reached on a unit, the field current is reduced by rotor over-current protection and part of its reactive power is transferred to the nearby units [7]. The remaining units become heavily overloaded causing their rotor protections to start functioning. At this moment, the generating units are no longer capable of maintaining their terminal voltage and the second disruptive phase of sharp voltage reduction causes system collapse [1].

A critical disturbance initially affects a limited region within the system, expanding gradually to a wide area [8]. Voltage instability is thus, primarily, a local problem. If proper countermeasures can effectively be applied to the most affected area in a well-timed manner, system breakdown can be avoided. In this way, the difficult task of system wide sequential actions, which include communications, analysis, prediction and decision making within a very short time can be minimized.

The event of voltage instability may occur in a system by both small and large disturbances. The large disturbances are caused mainly by outages of transmission lines and loss of generators. When a large disturbance happens, it may take some times (up to several minutes) for the system becomes

---

This work was supported by the Australian Research Council (ARC) linkage grant under Grant LP0991428.

S. R. Islam, D. Sutanto and K. M. Muttaqi are with the Department of Electrical, Computer and Telecommunication Engineering, University of Wollongong, NSW-2500, Australia (e-mail: sri703@uowmail.edu.au, soetanto@elec.uow.edu.au, kashem@uow.edu.au ).

unstable through the slow degradation of voltage profile. In this paper, this type of disturbances are considered for the analysis of voltage collapse and a multi-agent based dynamic approach is proposed to counter the voltage instability problem resulting from multiple transmission lines outages.

## II. PROPOSED APPROACH FOR PREVENTING VOLTAGE COLLAPSE AND POWER INTERRUPTIONS

The proposed emergency control approach incorporates three fundamental aspects, which are continuous monitoring of selected parameters, identification of a disturbance and actuation of timely countermeasures. The variations of electrical parameters such as voltage, reactive power output of the generators and power system losses are used to identify the occurrence of a disturbance. Once identified, the local intelligence at each disturbed area will be used to trigger timely countermeasures.

### A. Area Wise Analysis

At first, the whole system is divided into several areas. The criteria of forming area are that each area should have at least one generating unit and should include tap changing transformers at load substations.

Each area contains a team of agents. Each agent is in charge for monitoring the key parameters of a particular node and can directly communicate with other agents in the same area in order to make fast decision. There are two types of agents: *Generator Agent* and *Load Agent*. The generator agent has the information of the current capacity of the generator, the active and reactive power output, primary and secondary voltages at generating substations and generator transformer tap ranges. The load agent obtains information of the current amount of load, the primary and secondary voltages at the substation and load transformer tap ranges.

There is also a manager agent in each area assigned to monitor and manage the agents within its associated zone. The bus agents and the generator agents work under the supervision and command of the manager agent. The manager agent can also communicate with other managers in the surrounding areas. It has a limited view of the system and has to take correct decision based on its information of its associated area. For this reason, different manager agents can exchange their local information in order to make more accurate decision.

Some researchers have proposed an upper level in the hierarchy [9]. But the system response to most cases would be very slow if there are many layers in the hierarchy because the slave nodes (low level agents) have weaker decision making ability than the master nodes (higher level agents) and the final decision making will be made by the top master even if the crisis happens in a local area.

The advantage of the proposed area wise analysis is that it enables the system to respond quickly which is an essential requirement of an emergency control.

The Energy Management Centre (EMS) has to gather information of the system through communication links and communication path. This communication feature might increase communication costs and cause delay in decision making during emergency situations. Unlike the centralized control system, the area wise multi-agent approach can have a

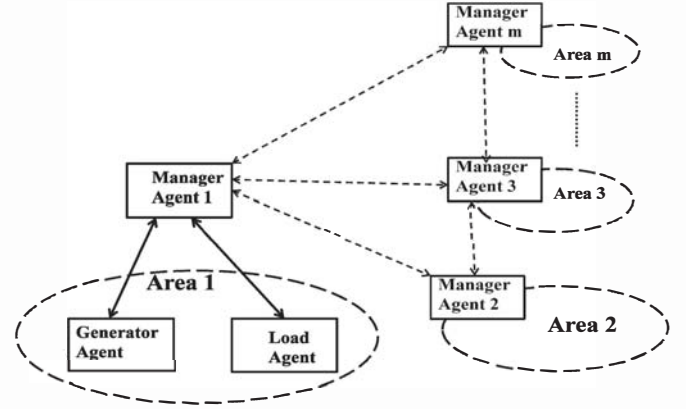

Fig.1. Multi-agent system architecture for the proposed control system  
low cost, faster and accurate control strategy of catastrophic disturbances.

### B. Indicator of Vulnerability

The voltage level is not alone a strong indicator for the voltage stability. The voltage levels might be normal, in certain cases, when the rotating units are operating close to the limits of their capacity. The identifying parameters for system voltage instability and voltage collapse are the reductions of transmission voltage levels and the increase of reactive power outputs on rotating units [7]. Any dangerous disturbance can be identified by measurements of these parameters changes.

Various performance indices have been proposed by researchers to articulate the severity of a contingency. In this paper, the performance indices have been developed based on the simple method described by Ejebe and Wollenberg [10].

The idea is simply to add all the differences between actual and desired voltages at all the nodes, divided by the voltage deviation limit as expressed in (1).

$$PI_V = \sum \frac{w_{iv}}{2} \left( \frac{|V_i| - |V_{i,sp}|}{V_{limit}} \right)^2 \quad (1)$$

where  $V_i$  is the actual voltage at bus  $i$ ,  
 $V_{i,sp}$  is desired voltage at bus  $i$ ,  
 $V_{limit}$  is the voltage deviation limit and  
 $w_{iv}$  is the weighting factor of each bus

The voltage deviation limit has been chosen  $\pm 5\%$  of its nominal value. The weighting factor represents the relative importance of the corresponding node in the network. A voltage drop on a particular node can have important consequences if this node is heavily loaded. Thus, the weighting factor has been defined as the ratio of the load of the respective bus to the total system load and expressed as below.

$$w_{iv} = \frac{P_i}{P_{total}} \quad (2)$$

where  $P_i$  is the active power load at bus  $i$  and  
 $P_{total}$  is the total active power load of the system.

The index associated with the reactive power output of the rotating unit is:

$$PI_Q = \sum \frac{w_{iq}}{2} \left( \frac{Q_i}{Q_{limit}} \right)^2 \quad (3)$$

where  $Q_i$  is the reactive power output of an unit and  
 $Q_{limit}$  is the reactive power limit of that unit

The weighting factor  $w_{iq}$  is tuned in a similar way.

$$W_{iq} = \frac{Q_i}{Q_{total}} \quad (4)$$

where  $Q_{total}$  is the reactive power load of the system.

The global performance indices are formed by combining these two as follows.

$$PI_{VQ} = PI_V + PI_Q \quad (5)$$

These performance indices are calculated for each agent. The countermeasures will be applied in each agent if the values of the performance indices exceed a certain limit following a contingency.

### C. Countermeasures

The countermeasures adopted for the control of voltage and reactive power overshoot include fast tap changing on high voltage (HV) substation transformers, raising synchronous condenser and generator terminal voltages and fast tap changing on generator transformers [1].

The main cause of voltage instability is the reactive power deficiency in the network. The root cause of July 2, 1996 system wide disturbance was a voltage decay within 30 seconds in the Idaho area as a result of insufficient reactive power support in that area [4]. The first control action is to increase the terminal voltages of generator and synchronous condensers to supply reactive power to the system. The transformer taps are fixed to avoid uncoordinated tap changing of distribution and sub-transmission transformers. The sequential study calls for fast tap changing in the transmission substation to avoid reactive power overshoot.

When a catastrophic disturbance is identified, each agent in each local intelligent area will track the system parameters. The information of the reactive power output of the generators and synchronous condensers, the load bus voltages are supplied to the manager agent by the generator agent and the load agent, respectively. Based on the reactive power –time curve of the generator over-excitation limiter protection curve, the manager agent makes a quick decision on the timing of the countermeasures.

The most effective measure is the strategic load shedding. Since the final phase of voltage collapse occurs suddenly, there is not sufficient time for operator actions to stabilize the system. Thus, manual load shedding cannot be relied upon to stabilize the interconnected system and to mitigate the voltage collapse. Therefore, automatic load shedding is required. Before strategic load shedding, the other countermeasures should be adopted in the initial slow phase. Strategic load shedding should act as a last resort [3].

Only the area with a large value of performance indices will carry out load shedding. Once the load shedding is activated, the information is sent to all areas as well as to the control centre. The effectiveness of load shedding will then be evaluated and if necessary further countermeasures are to be activated.

The amount of load to be shed for the control of system voltage stability is determined by the voltage reduction in each bus [3]. The allocation of load shedding in each of the identified substations would be in proportion to the voltage reduction multiplied by the voltage sensitivity [11]. This can be evaluated as:

$$\Delta Q_i = \Delta V_i \left( \frac{\partial Q_i}{\partial V_i} \right) \quad (5)$$

$$\Delta P_i = P_i \left( \frac{\Delta Q_i}{Q_i} \right) \quad (6)$$

where  $\Delta Q_i$ ,  $\Delta P_i$  is the amount of load shedding at bus  $i$ ,  $P_i$ ,  $Q_i$  is the load before shedding and  $\Delta V_i$  is the voltage reduction at bus  $i$ .

### D. Further measures

After strategic load shedding, the system performance is evaluated whether it has regained the normal state or not. If not, then further countermeasures are activated. Among these measures, there is a second load shedding in those buses where the voltages are still below the normal value. The application of load shedding in these buses may cause other bus voltages to increase beyond their nominal value. Therefore, some tap lowering will be needed to bring down these voltages to their pre-disturbance values.

## III. CASE STUDY

### A. The Test System

The IEEE 57 bus system is used as a case study. This test power system represents a portion of the American Electric Power System (in the Midwestern US) as it was in the early 1960's. It has 4 generators, 3 synchronous condensers and 80 lines. There are 3 shunt capacitors and 17 load transformers with on-load tap changing (OLTC) capabilities. The 57 bus test case does not have line limits. The loads are assumed to have constant complex power because the constant power representation of load is the most severe case from voltage stability view point [12]. The parameters of test system can be found in [15].

As stated earlier, voltage instability is a local problem in the network. The danger created by a disturbance can be substantially reduced by promptly identifying the location of the interruption and applying appropriate countermeasures. For the purpose of analysis, the 57 bus system is divided into four local intelligent areas or zones. Each local intelligent area has information of the attributes of each node that includes the dynamic information of the power network voltages, generator reactive power, power flows and the status of neighboring nodes.

The manager agent in each local intelligent area continually calculates the value of the performance indices of each area. If this value exceeds a certain threshold limit, the agent will initiate an alarm that the system has entered into an emergency state. This will indicate the occurrence of any critical disturbance as well as voltage instability and reactive power deficit problem in that area. The automatic countermeasures will be applied by the agent to restore the system to normal state.

The countermeasures developed based on the study conducted by [1] and [3] are given in Table 1 showing the sequence and timing of the countermeasures. The transformer tap change timing is based on the typical operation of an Australian power system.

The 57 bus test system does not have any generator transformer. As a result, fast tap changing occurs in only the load transformers. The effect of generator transformer tap changing can be obtained by increasing the terminal voltage of the generators [3].



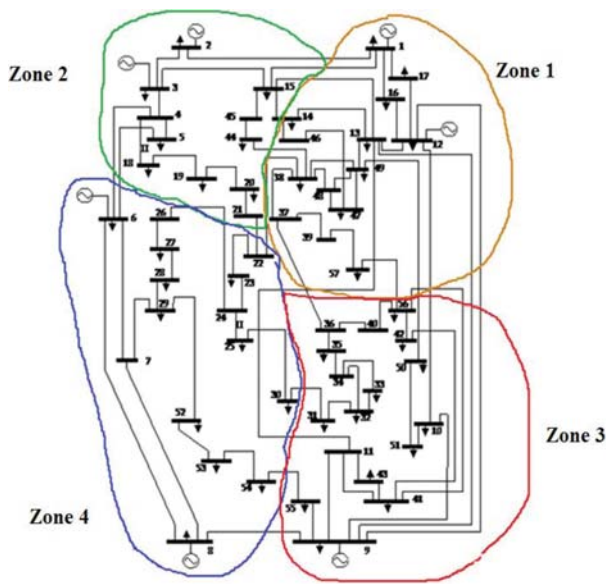

Fig.2. IEEE 57 bus test system

TABLE I  
TIMING OF COUNTERMEASURES

Step	Time	Countermeasure
1	0	Critical disturbance
2	5	Terminal voltage raised in selected synchronous condensers and generators
3	10	Load transformer tap change: 1%
4	18	Load transformer tap change: 1%
5	26	Load transformer tap change: 1%
6	30	Strategic load shedding
7	50	2 <sup>nd</sup> load shedding (Optional)
8	58	Load transformer tap change: 1%
9	66	Load transformer tap change: 1%

The strategic load shedding is followed by a 2<sup>nd</sup> load shedding only in those buses where the voltages are not still recovered by the 1<sup>st</sup> load shedding. Following [12], it has been assumed that the loads are constant power factor loads and maximum 80 percent of the connected load can be shed in each bus.

The interval between each tap change in the load transformers is 8 seconds and the transformer will tap up or down where there is more than 1.5% deviation in the voltage [3] from the pre-disturbance value. The first three tap changes try to increase the load bus voltages to their pre-disturbance value. The final two tap changes are for those buses where the voltages have exceeded their pre-disturbance values, thereby, the transformer tries to tap lower to regain the voltage.

#### A. Disturbance

To test the proposed decentralized emergency control system, the following two cases of contingency are examined.

- (i) Case 1: Line outages of line 1-15, 1-17 and 36-37.
- (ii) Case 2: Line outages of line 7-8, 22-28 and 36-37.

These lines are selected because each disturbance creates heavy increase in system reactive power demand due to the large increase of series reactive power losses in the transmission lines.

#### B. Case 1: Line outages of line 1-15, 1-17 and 36-37

These lines are in zone 1. Lines 1-15 and 1-17 are heavily loaded lines. The voltage profile before and after the line outages are given below.

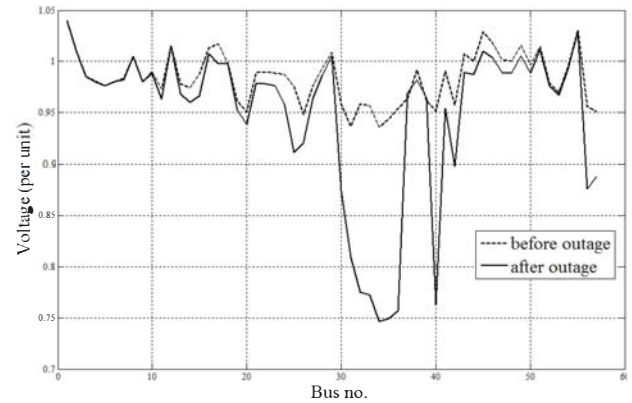

Fig.3. Voltage profile of the system before and after the line outages

The voltages in the load buses mainly in area 3 are mostly affected by the disturbance. The voltage reduction caused an over-excitation on the synchronous condenser at bus 9 from 2 to 21 MVar. The generators at bus 3 and 12 are also over-excited and increase their reactive power beyond their reactive power limits.

In the simulation, the generator reactive power outputs are allowed to exceed their continuous ratings until their rotor current limiter actuates.

The system summary before and just after the line outages are given below.

TABLE 2  
SYSTEM SUMMARY BEFORE AND AFTER THE LINE OUTAGE

	Before		After	
	P (MW)	Q (MVar)	P (MW)	Q (MVar)
Power generation	1278.6	322.3	1313.9	440.7
Losses	27.84	122.65	63.12	239.16
Max voltage	1.040 p.u. @ bus 1		1.040 p.u. @ bus 1	
Min voltage	0.936 p.u. @ bus 34		0.746 p.u. @ bus 34	

The voltage at buses 31-36 and bus 40 are adversely affected (reach below 0.8 per unit) by the disturbances. The reactive power losses have increased by 95% from 122.65MVar to 239.16MVar.

The performance index for each zone is

TABLE 3  
VALUE OF THE PERFORMANCE INDICES

	Value of PI
Zone 1	0.4144
Zone 2	0.4705
Zone 3	0.8595
Zone 4	0.0585

The threshold value chosen for the simulation is 0.5, therefore agent in zone 3 will be alerted to start the

countermeasures. The sequential control actions are then executed by the manager agent in zone 3 to attempt to restore the system.

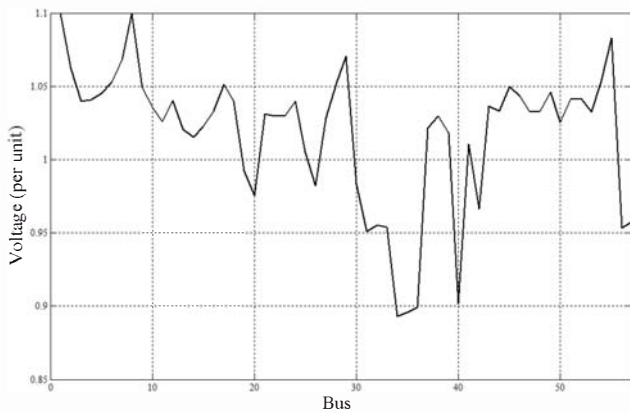

Fig.4. Voltage profile of the system after the countermeasures are applied by only agent 3

After the countermeasures are applied in Zone 3, the entire load bus voltages are within the limit of 0.9-1.1 p.u. (the slight deviation at bus 34 may be acceptable as it is on the primary side of a load transformer and there is no load is connected to it).

Fig. 5 shows the progression of voltage change in bus 32, one of the worst affected buses. The numbers denote the countermeasure step number. Just after the disturbance, the voltage level drastically reduced at some load buses in area 3. The first action is the raising of terminal voltages on selected condensers and generators. This improves the voltage level at the load buses quite a lot, followed by a step by step voltage increment by tap changing in the load transformers. Finally, strategic load shedding restored most of the buses to their pre-disturbance level of voltage. The final two tap changes (tap lowering) regained the load voltages where load shedding had raised voltages above the pre-disturbance levels.

C. Case 2: Line outages of line 7-8, 22-38 and 36-37

These lines are in Zone 1 and Zone 4. Line 7-8 is a heavily loaded line. The voltage profile before and after the line outages are given in Fig. 6.

In this case, the load voltages in both the Zone 3 and Zone 4 are affected significantly. This can be exemplified by the performance indices. A large value of PI in Zone 3 and 4 indicates that these two areas are experiencing the severest after-effect of the disturbance.

Using the same threshold value of 0.5, agents in Zone 3 and 4 will now carry out the countermeasures to attempt to restore the power system to its pre-disturbance level. Fig. 7 show the result of the countermeasures and the combined effect of

TABLE 4  
VALUE OF THE PERFORMANCE INDICES

	Value of PI
Zone 1	0.0414
Zone 2	0.0485
Zone 3	1.2527
Zone 4	1.7488

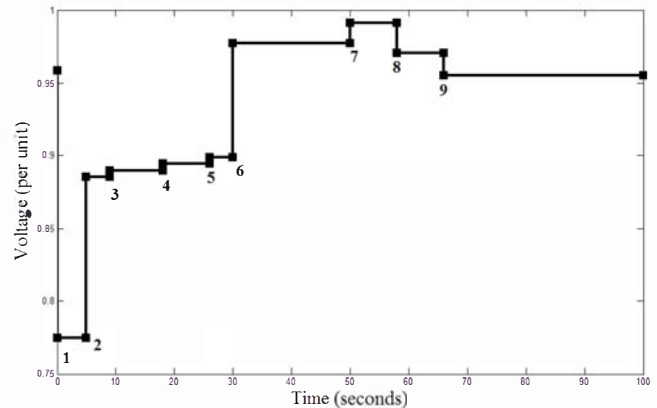

Fig.5. Change in the load voltage in bus 32 by the applied countermeasures.

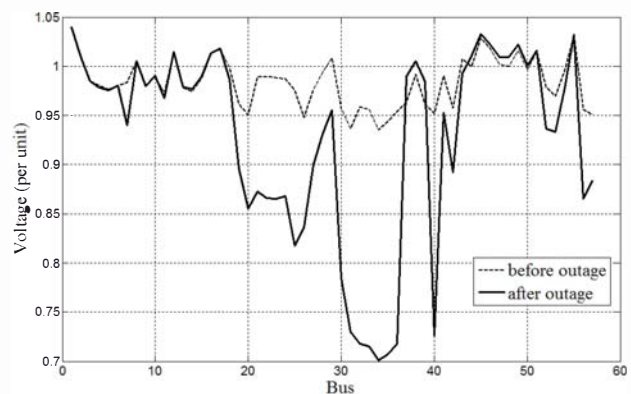

Fig. 6. Voltage profile of the system before and after the line outages control actions in both Zone 3 and 4 in scenario 2 have improved all the bus voltages almost to same level by the centralized actions. This demonstrates the effectiveness of the proposed area wise analysis.

To investigate the effect of varying the threshold value, two scenarios are chosen: (i) threshold value = 1.5 and (ii) threshold value = 0.04. In the first case, only region 4 is allowed to carry out the countermeasure and in the second case all zones are allowed to carry out the countermeasures. This is then similar to the case of a centralized controller that has access to all the system information and can perform the countermeasures throughout the power system.

Fig 7 shows the comparison of the voltage profile using the centralized approach where the countermeasures are carried in all four zones having the information available in the four zones and the voltage profile obtained when only the agents in Zones 3 and 4 or only in the Zone 4 perform the countermeasures. Fig. 8 shows the progression of voltage change in bus 32, one of the worst affected buses. The numbers denote the countermeasure step number.

As expected, the results from the centralized controller is much better compared to the case when the countermeasure is only carried out in one or two zones and the worst when only one zone performs the countermeasure. This suggests that a correct choice of threshold value is important to ensure that the countermeasures can restore the power system to its pre-disturbance level.

However, one of the important features of determining the correct zones to perform the countermeasures is to allow fast

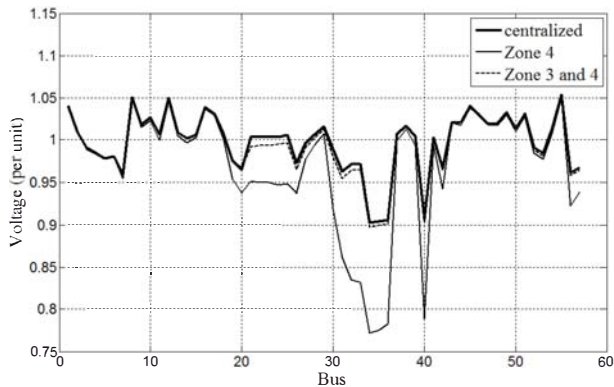

Fig. 7. Voltage profile of the system for different scenarios.

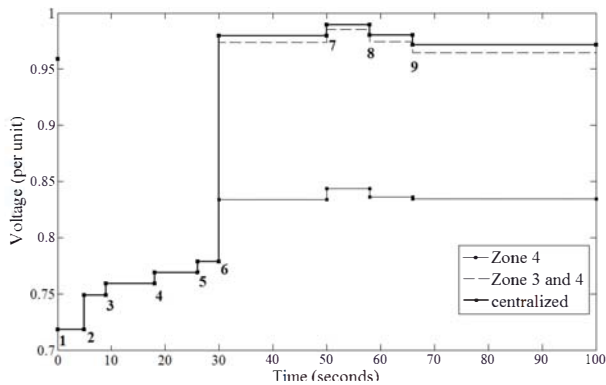

Fig. 8. Change in the load voltage in bus 32 by the applied countermeasures. response from the most affected area. The results from the countermeasures carried out in Zone 3 and 4 are very similar to that obtained when the countermeasures are carried out centrally, suggesting that timely countermeasures at the most affected area works as well as performing the countermeasures centrally which is usually slower than local countermeasures.

#### IV. CONCLUSION

This paper proposes a multi-agent based decentralized approach to mitigate voltage instability. To counter the voltage instability, it is recommended to actuate control action at precisely the locations impacted by a disturbance and a strategic load shedding is suggested after the other measures fail to avoid wide spread power outage. A suitable value of the threshold of the performance indices can be determined for every system to initiate the countermeasures.

A hierarchical communication arrangement is necessary for system protection where the intelligent agent would activate the fastest response at the lowest level of the hierarchy. In this manner, timely and effective measures would curtail the spread of the disturbance affect and a total or partial black out of a large power system can be avoided.

#### V. ACKNOWLEDGMENT

This work is supported by the Australian Research Council (ARC) and Transgrid Linkage Grant, LP0991428. The authors gratefully acknowledge the financial support and cooperation from Transgrid.

#### VI. REFERENCES

- [1] W.R. Lachs and D. Sutanto, "Voltage instability in interconnected power systems: a simulation approach," *IEEE Transactions on Power Systems*, vol.7, no.2, pp. 753-761, May 1992.
- [2] Blackout of 2003: Description and Responses, available: <http://www.pserc.wisc.edu/>.
- [3] W.R. Lachs, "Dynamic Study of an Extreme System Reactive Power Deficit" *IEEE Transactions on Power Apparatus and Systems*, vol. PAS-104, no.9, pp. 2420-2426, Sept. 1985.
- [4] C.W. Taylor and D.C. Erickson, "Recording and analyzing the July 2 cascading outage [Western USA power system]," *IEEE Computer Applications in Power*, vol. 10, no.1, pp. 26-30, Jan 1997.
- [5] W.R. Lachs, "A New Horizon for System Protection Schemes," *IEEE Transactions on Power Systems*, vol.18, no.1, pp. 334-338, Feb 2003.
- [6] P. Kundur, "Power System Stability and Control", McGraw Hill, 1994.
- [7] W.R. Lachs and D. Sutanto, "Protection for the Transmission grid", *Sixth International Conference on Developments in Power System Protection, (Conf. Publ. No. 434)*, pp. 201-205, Mar 1997.
- [8] W. R. Lachs, "Controlling grid integrity after power system emergencies," *IEEE Transactions on Power Systems*, vol. 17, No. 2, pp. 445-450, May 2002.
- [9] D.A. Panasetsky, P. V. Etingov and N.I. Voropai, "Multi-agent approach to emergency control of power system", *Third International Conference on Electric Utility Deregulation and Restructuring and Power Technologies*, pp. 2157-2161, Apr 2008.
- [10] G. Ejebe and B. Wollenberg, "Automatic contingency selection", *IEEE Transactions on Power Apparatus and Systems*, vol.PAS-98, no.1, pp.97-109, Jan. 1979
- [11] D.Prasetjo, W.R.Lachs and D.Sutanto, "A New Load Shedding Scheme for Limiting Underfrequency", *IEEE Transactions on Power System*, vol. 9, no. 3, pp. 1371-1378, Aug 1994.
- [12] T.Q. Tuan, J. Fandino, N. Hadjsaid, J.C. Sabonnadiere, H. Vu, "Emergency load shedding to avoid risks of voltage instability using indicators", *IEEE Transactions on Power Systems*, vol. 9, no. 1, pp. 341-351, Feb 1994
- [13] W. R. Lachs. "Reactive Power Control in System Emergencies", *International Conference on Power System Monitoring and Control*, pp. 149-153, 1980.
- [14] D.A. Panasetsky and N.I. Voropai, "A Multi-Agent Approach to Coordination of Different Emergency Control Devices Against Voltage Collapse", *IEEE Bucharest Power Tech Conference*, pp. 1-7, June 2009.
- [15] "Power Systems Test Case Archive: 57 Bus Power Flow Test Case", Available:[http://www.ee.washington.edu/research/pstca/pf57/pg\\_tca57bus.htm](http://www.ee.washington.edu/research/pstca/pf57/pg_tca57bus.htm)
- [16] W.R. Lachs, "Resolving the impasse in Emergency System Operation", *IEE Proceedings C, Generation, Transmission and Distribution*, vol.134, no. 5, pp. 331-336, Sept. 1987.
- [17] N. Shah, A. Abed and C. Thomas, "Under Voltage Load Shedding Guidelines", Under-voltage Load Shedding Task Force, Technical Studies Subcommittee, Western Systems Coordinating Council, July 1999.

#### VII. BIOGRAPHIES

**S. R. Islam** a post-graduate student at the University of Wollongong, Australia. He received B.Sc. Degree in Electrical and Electronics Engineering from Bangladesh University of Engineering and Technology, Dhaka, Bangladesh in 2009. His research interests include power system stability, emergency control and application of multi-agent system on power system.

**Danny Sutanto** (SM'88) is a Professor of Power Engineering at the University of Wollongong, Australia. He obtained his B.Eng. (Hons) and Ph.D. from the University of Western Australia in 1978 and 1981, respectively. His research interests include power system planning, analysis and harmonics, energy storage systems and voltage stability.

**K. M. Muttaqi** (SM'05) is an Associate Professor of Power Engineering at University of Wollongong, Australia. He received the Ph.D. degree from Multimedia University, Malaysia in 2001. His research interests include distributed generation, renewable energy, intelligent grid, power quality and reliability.