



UNIVERSITY
OF WOLLONGONG
AUSTRALIA

University of Wollongong
Research Online

University of Wollongong in Dubai - Papers

University of Wollongong in Dubai

2016

Integrated broadband powerline and visible light communication (VLC) using OFDM and turbo coding

Nader Nassar

University of Wollongong in Dubai

Nidhal Abdulaziz

University of Wollongong in Dubai, nidhal@uow.edu.au

Publication Details

Nassar, N. & Abdulaziz, N. 2016, 'Integrated broadband powerline and visible light communication (VLC) using OFDM and turbo coding', *International Journal of Computer and Information Sciences*, vol. 12, no. 1, pp. 33-41.

Research Online is the open access institutional repository for the University of Wollongong. For further information contact the UOW Library:
research-pubs@uow.edu.au

Integrated Broadband Powerline and Visible Light Communication (VLC) using OFDM and Turbo Coding

Nader Nassar Nidhal Abdulaziz
University of Wollongong in Dubai
nadernassar@outlook.com nidhal@uow.edu.au

Abstract: This paper is focused on the communication scheme and its integration of Power Line Communication (PLC) and Visible Light Communication (VLC) systems. As the power line communication is becoming more popular in the last mile and home networking. In order to make the Power Line Communication (PLC) based networks more practical by having mobility at the last inch connectivity the VLC can be utilised. Some work has been done in the area of using power line for communications but these systems suffer from noise, inter symbol interference (ISI), and distortion. Most of the current proposed integrated systems are through Direct Sequence Spread Spectrum (DSSS) and OFDM techniques, where they are considered as candidates for future broadband PLC networks. Our work is different in a sense that it is incorporating turbo codes in the integrated system to increase the system robustness to noise, ISI and distortion. The signal data to be transmitted will be connected through the Power Line modulator which is connected to the wall socket. The PLC modulator is then connected to the VLC modulator for the transmission of the signal in the air. At the receiver side however, the transmitted signal is then received through the VLC demodulator followed by the PLC demodulator. By introducing the turbo coder and decoder we were able to achieve a better performance for the integrated system to noise, ISI, and distortion. The performance of the system was measured through comparing the BER rate for the system with and without the turbo codes. The BER rate was also measured with respect to the signal to noise ratio, and data rate. Simulation results using Matlab was conducted to show the systems performance towards noise and other factors. A practical implementation for the PLC was assembled to better support the simulation results.

Keywords: Power Line Communication System (PLC); Visible Light Communication System (VLC); band-pass filter (BPF); Signal-to-noise ratio (SNR), Non Line of Sight (NLOS).

Received: July 30, 2016 / *Revised:* August 10, 2016 / *Accepted:* August 25, 2016

1. Introduction

This research project is investigating the performance of a system that integrates both Power Line Communication (PLC) and Visible Light Communication (VLC) systems using OFDM and Turbo Code. As the telecommunication industry has been going under some technological enhancements such as, delivering broadband services with high data rates of transmission, that aims not only in improving the communication medium, yet having it cost effective, through the power line (PL) existing infrastructure. By taking an advantage of the power line as a communication medium, it could be a cost effective way since it does not require an additional communication line, and can cover almost all the grid locations for an indoor communication system [1].

Most of the current proposed integrated systems are through Direct Sequence Spread Spectrum (DSSS) and OFDM techniques, where they are considered as candidates for future broadband PLC networks. Some work has been done in the area of using power line for communications but these systems suffer from noise, ISI, and distortion [2]. Our work is different in a sense that it is incorporating turbo codes in the integrated system to increase the system's robustness to noise and distortion. Figure 1 below shows the basic diagram of an integrated PLC VLC system. The input data to be transmitted will be connected through the Power Line modulator which is connected to the wall socket. The PLC modulator is then connected to the VLC modulator for the transmission of the signal in the air. At the receiver side however, the transmitted signal is then received through the VLC

demodulator followed by the PLC demodulator.

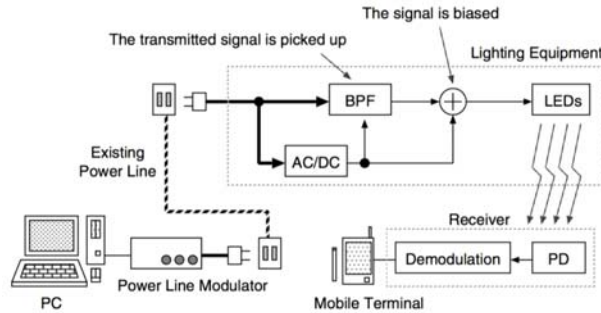

Figure 1: Visible Light Communication (VLC)

Due to the LOS (line-of-sight) communication, the VLC has served as a great advantage and is an appealing solution for the indoor family broadcasting, and could be well extended to the scenarios including the hospitals, shopping malls, stadiums, music halls, and many more. Nevertheless, when it comes to the confidentiality and security of information VLC takes the responsibility [1]. Researchers at the University of Pennsylvania [2], conducted their research about the military aircraft electrical line network which offers relatively high capacity bus. Further, for them to meet the designed integrated system of the aircraft, they designed a system with white LEDs for faster and high data rate of transmission by limiting the blind spot, yet achieving the luminosity of the whole cabin [3].

2. Powerline Communication System

In the last couple of years Power Line Communications (PLC) has emerged as a reliable Ethernet alternative to traditional unshielded twisted pair (UTP) category 5 and 6 (CAT5/6) installed in homes and buildings [4]. The use of the power lines for networking has the advantages of providing a high data speed of transmission, subsequently, achieving a better network coverage [4, 5]. Electrical supply networks have been an increasing interest in supplying a broadband communication network through their current existing infrastructure. Also, the users will no longer has to re-establish a physical connection as the PLC system already acts as the backbone network [7, 8]. The PLC can be divided into different frequency bands: narrowband and broadband PLC. Through narrowband, limited frequency and coverage can be passed through with a frequency range up to 150kHz, and a theoretical bit rate of 2 Mbits/s. Whereas, the broadband can operate with a frequency ranging from 150kHz up to 3MHz, with a theoretical bit rate of 200Mbits/s [8]. To achieve the best outcome in broadband power line communication (BPLC), it is important to choose precisely the best modulation technique.

2.1 Channel noise effect on PLC system

The PL channel can be modelled as a time varying frequency- selective fading with additive noise, where

it can be expressed mathematically as [9],

$$H(f) = \sum_{l=1}^{L-1} g_l e^{-(\alpha_0 + \alpha_1 f^k) d_n} e^{-j2\pi f (\frac{d_n}{v_p})} \quad (1)$$

where L is the total number of reflection paths, g_l represents the complex tap factors for each path, α_0 and α_1 are the attenuation factors, k is the exponent of the attenuation factor, d_n is the path length, and v_p is the velocity of propagation [4]. There are other types of noises affecting the channel, the additive white Gaussian noise (AWGN) is not the only noise affecting the channel, there are other noises such as:

- Background noise
- Narrowband noise
- Periodic and aperiodic impulsive noise

Moreover, it has been found that the background noise is mainly caused by buildings and residential electronic equipment having a power spectral density (PSD) function shown in equation 2 below,

$$s_n(f) = -140 + 75e^{\frac{|f|}{5 \times 10^5} \frac{dBm}{Hz}} \quad (2)$$

The power line (PL) channel is susceptible to impulsive noise interference which is generated through electrical appliances. This impulsive noise may cause either bit or burst errors in data transmission power line [6, 13, 14].

When it comes to narrowband noise, it can be modeled as the output of the bandpass filter driven by the AWGN in the discrete sampling space, which can also be represented as a low frequency sinusoid [9, 12, 13],

$$n_{nb}(k) = w(k) \sin(2\pi f_c k) \quad (3)$$

where f_c is the carrier frequency of the interferer, and n_{nb} based on prior research has been found to reach power levels of 30 dB greater than the background noise at frequencies greater than 1 MHz .

3. Visible Light Communication System

Visible Light Communication (VLC) based on LED's as shown in Figure 2, can be used in different applications due to their vast safety and security features. Communication through devices, such as PC's, tablets, smartphones and so on, can now easily communicate at a high data rate of transmission without the interference of other radio frequency bands. Due to the fast switching of LED's and the modulation of the visible light waves for free-space communications, the system will now be able to

operate at a high power to function as a lighting device [6].

White LEDs are considered to be more efficient than the current existing incandescent fluorescent light bulbs. Communication through LEDs are considered to [3, 4]:

- Be cost efficient
- Obtain a secure transmission through line of sight (LOS) communication
- Have less shadowing effect in comparison to the IR, as the lights are distributed all over the room
- Have a longer lifetime

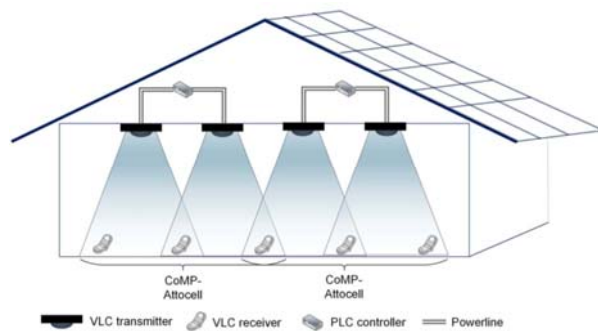

Figure 2: Visible Light Communication (VLC)

4. Integration of PLC and VLC

Power line communication is becoming more popular in the last mile and home networking. In order to make the Power Line Communication (PLC) based networks more practical by having mobility at the last inch connectivity the VLC can be utilised. The ubiquitous nature and advantages for which these two medium of communication possess can be harnessed, such that VLC is made to offer a good complementary wireless data communication to the existing ubiquitous In-House PLC channel [12]. The idea of integrating both systems was pioneered by Komine et.al in 2002 [9], which has now been taken advantage of in various applications [1, 2].

Komine et al. researched the effect of noise in PLC, for he was also able to find that due to the cyclic impulsive noise in power-line channel if SNR_{pl} is greater than 4dB, the performance would degrade to almost lessen, compared with the communication cable. The same authors examined the performance of the proposed system which emits as light of LED lighting from the power line signal without demodulation. They came to a conclusion of that as the SNR_{vl} increases, it also increases the performance that of the PLC [2, 16].

The limitations to their approach can be shown below:

- The approach has failed to overcome the noise in the PL channel.

- Multipath effects were not considered in PL.
- Their work was based on the narrowband PLC, hence they had a limited BW.

To begin with the wiring system of the optical communication using the power line as shown in Figure 3, the sending device will be connected through the Power Line Modulator (PLM) which is then connected to the wall socket. By taking an advantage of the existing wiring infrastructure, the signal is then converted from AC to DC in addition to passing through the Band Pass Filter (BPF) where the signal is biased and sent to the lighting equipment (LED's) [4, 9, 10].

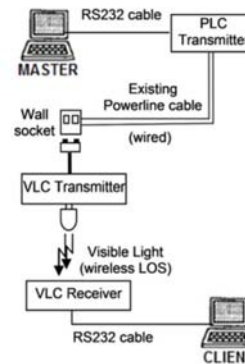

Figure 1: System Design

5. Channel Coding

Some research has been done in the area through the addition of convolution blocks such as the interleaved coding, which has been adopted to overcome the impulsive noise, and frequency-selective behaviour of PL networks as they cause burst noise which debilitates the high speed communication [5]. However, Anatory, and Theethayi have proposed a concatenated Reed-Solomon codes (RS)/interleaved Vitebri channel coding to enhance the burst error corrections, in addition to having a very high coding rate with a low complexity power [6, 13].

Back in 1993, Berrou, and Glavieux presented a new channel coding scheme which has provided better results in the coding scheme [15]. On the other hand, the importance of turbo codes is to minimise the BER rate, yet delivering a broadband service, for they have been proven to be efficient for coding in horrible channel conditions.

To begin with the integration system as shown in Figure 4, the turbo code will be connected in parallel concatenation of two recursive systematic convolutional (RSC) encoders separated by an interleaver.

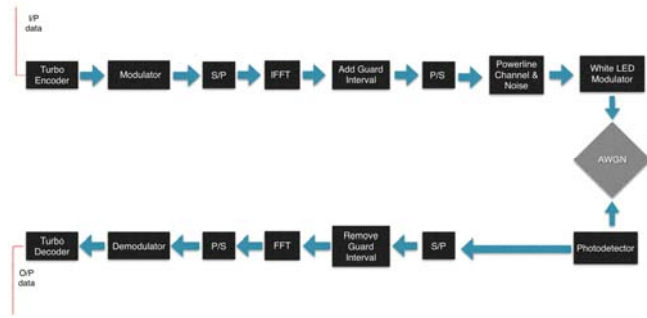

Figure 2: Integrated system block diagram

The parallel concatenation code (PCCC) means that that the information is recorded twice. Nevertheless, by incorporating turbo codes in the integrated system to increase the system robustness to noise and distortion [1, 24].

6. System Design

This Chapter describes the overall architecture of the PLC and VLC system, along with the methodological approach for which has been taken to further enhance the channel noise effects under the impulsive and AWGN respectively. The below sections elaborate on the PLC channel and its mathematical modelling through BPSK modulation, subsequently, the integrated system, followed by the practical implementation.

6.1 PLC Channel Modelling

When the data is being transmitted through the PLC channel, they are degraded by noise and attenuation as shown in Figure 5. The PLC channel suffers from Impulsive and Narrowband noise that is generated by the connected electrical appliances [6]. On the other hand, the indoor power lines can be categorised as medium transmission lines, since the distance is a few hundred meters with non-negligible capacitance, where it can be also expressed mathematically as shown below in equation 4 [11, 28],

$$\text{Capactiance, } C, \text{ in } \frac{\mu\text{F}}{\text{km}} = \frac{\epsilon_r D}{18 \ln \frac{D}{a}} \quad (4)$$

Where D is the diameter over the insulation and ϵ_r is the material's insulation permittivity, and finally the magnitude response can be expressed as in equation 5,

$$\left| \frac{V_r(j\omega)}{V_s(j\omega)} \right| = \frac{2}{\sqrt{(2-LC\omega^2)^2 + (\omega RC)^2}} \quad (5)$$

where L is the inductance, C is the capacitance, R is the resistance, and ω is the angular frequency.

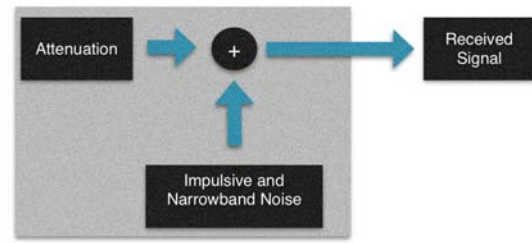

Figure 5: PLC channel

In the conventional communication systems, the channel noise is usually modelled as the AWGN which is set to have a constant power spectral density throughout the whole spectrum. Moreover, other types of noise, mainly background noise, narrowband noise, including periodic and aperiodic noises add up to the channel. An intuitive description was given in [18] about various types of noises that aimed in encompassing the overall PLC noise as the superposition, in addition to the five different types distinguished by their tie duration, origin, spectrum occupancy and intensity [28, 29, 30].

6.1.1 Modulation through PLC Channel

The modulation technique of using BPSK through the PLC channel can be shown in Figure 6. To begin with, the input data stream is modulated using BPSK and converted into 1 and 0s. Followed to the modulation of the data stream, it is then passed through the PLC channel which is subjected to noise. The wireless channel is represented as the AWGN, which is then added to simulate the output of the Powerline Communication channel. At the receiver side however, the BPSK signal is then demodulated and detected for 1 and 0s. Finally, the BER curves are then obtained from the input data streams and number of errors.

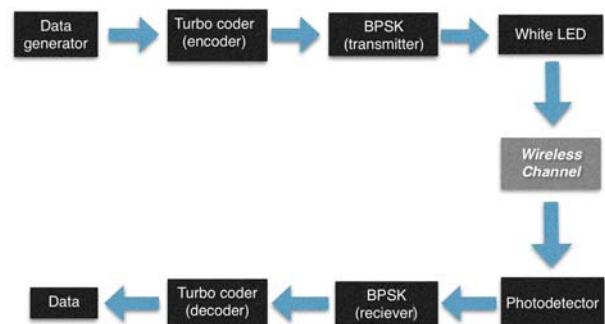

Figure 6: Modulation through PLC channel

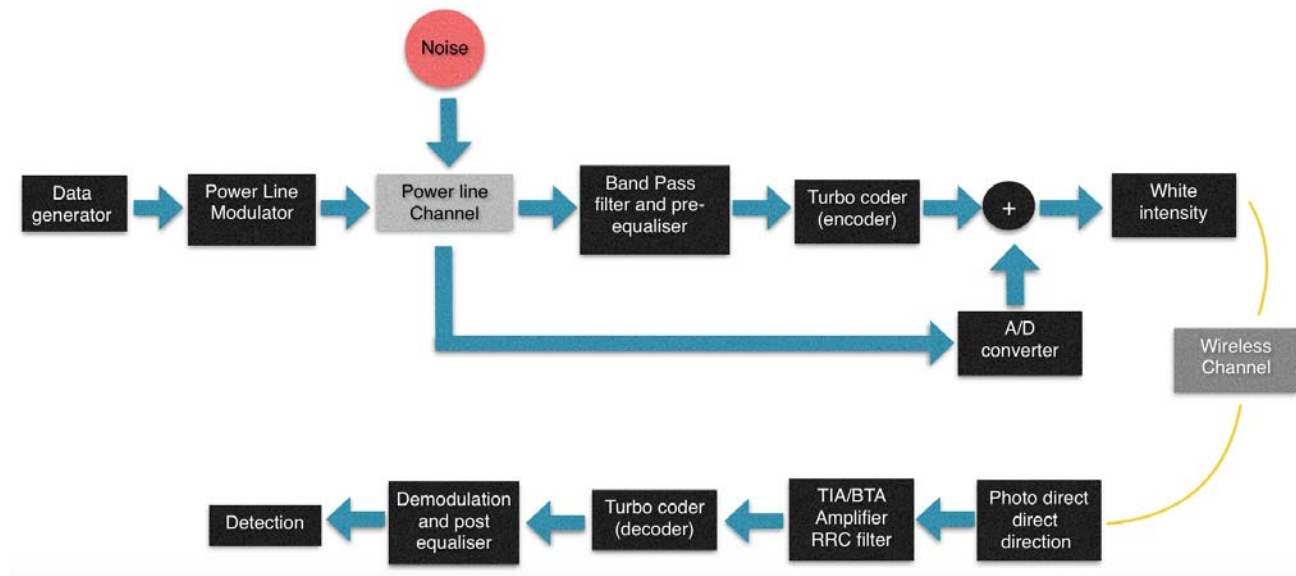

Figure 7: Integration of PLC and VLC using turbo codes

7. Integrated System with Turbo Codes

The PLC and VLC integrated block diagram is shown in Figure 7. In this integrated system, the signal will pass through the PL Modulator, then through the PL channel where it will be subjected to noise, and so through the VLC system. The VLC system comprises of a pre-equalizer circuit to optimize the SNR, a turbo coder which is formed by parallel concatenation of two recursive systematic convolutional (RSC) codes, separated by an interleaver. One of its main characteristics is that it aims to improve the BER rate, and an AC/DC converter before it is transmitted to the modulator. Due to the harsh channel properties such as, the multipath propagation and impulsive noise generated by the appliances, it has been made difficult to implement the PLC system [20]. On the other hand, the turbo codes have been proven to be efficient in the horrible channel conditions and their capabilities of correcting burst errors. A proposed integrated system is being elaborated on for which aims to increase the system robustness to noise and distortion [1, 26, 27]. The power of each LED in the LED lighting is varied according to the waveform of the signal.

The light from the LED lighting is received at the mobile terminal via photo-detector, and the signal is demodulated according to the level of luminance of light. This is followed by the raised cosine filter circuit, followed by the demodulator and post equalizer to extract the signal. The integrated PLC and VLC system transmission can be represented by the below equation 6 [12],

$$r(t) = h(t)*s(t) + n(t) \quad (6)$$

Where $r(t)$ is the received signal, $h(t)$ PLC channel impulse noise, $s(t)$ transmitted signal and finally $n(t)$ represent the channel noise.

Matlab simulation have been conducted along with the hardware implementation that are covered in the following chapters, and sections.

8. Simulation and Results

This chapter will give an overview of the various Matlab simulation results that have been conducted, such as the BER measurement with respect to the signal-to-noise ratio (SNR), and data rate with and without the addition of turbo codes. The AWGN however, was used to simulate the wireless channel, which successfully met the objective of the topic, and that is the 'Integrated Broadband Powerline and Visible Light Communication (VLC) using OFDM and Turbo Coding'. Nevertheless, also practical implementation was also achieved by building the PLC channel.

9.1 Performance Error in the Gaussian Channel

In the NRZ scheme a pulse with duration equal to the bit duration is transmitted to represent 1 whereas, in the RZ scheme the pulse occupies only the partial duration of bit. Figure 8 below depicts, a single mapping of OOK-NRZ and OOK-RZ, yet having the duty cycle to be $\gamma=0.5$ for an average transmitted power of P_{avg} . Therefore, the envelop for the OOK-NRS can be expressed as [22],

$$\begin{cases} 2P_r, & \text{for } t \in [0, T_b) \\ 0, & \text{elsewhere} \end{cases}$$

where P_r is the average power and T_b is the bit duration.

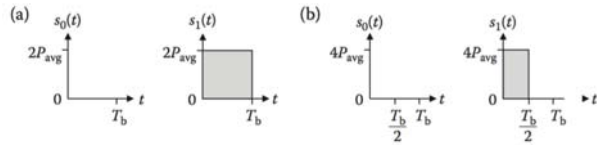

Figure 8: Transmitted waveforms for OOK: (a) NRZ and (b) RZ ($g = 0.5$) [22]

On the other hand, as per the matched filter the variance of the noise samples at the output is dependent solely on the PSD of the input noise as well as the energy in the impulse response of the matched filter. Hence, if the input was set to be AWGN double sided PSD $N_0/2$, the variance of the noise at the output of the matched filter can be represented mathematically as follows [22],

$$\sigma^2 = \frac{N_0}{2} \int_{t=0}^{T_b} r^2(t) dt \quad (8)$$

where, the standard deviation can also be represented as,

$$\sigma = \sqrt{\frac{N_0 E_p}{2}} \quad (9)$$

The below graph shown for the OOK-NRZ in Figure 9, represents the BER vs S/N ratio for OOK without any turbo codes just using AWGN for the wireless channel is this is the case.

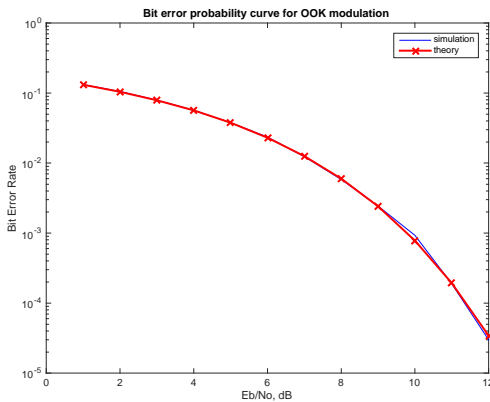

Figure 9: BER of OOK-NRZ

Other types of modulation have also been simulated such as OFDM, to show the performance improvement, with the use of turbo codes, a new simulation has also been conducted with different types of convolutional code. For example, $2/3$, $1/2$.

9.2 PLC channel modelling

Reference to section 2.1, the PLC channel can be designated into background noise, and impulsive noise, where the background noise can be characterised as the additive white Gaussian noise (AWGN), with zero

mean and variance σ_w^2 . The arrival process follows a Poisson process [23] with arrival rate of λ per second, hence the probability distribution is the event of k arrivals in t seconds, which can also be expressed below by equation 10 [24],

$$P_k = e^{-\lambda t} (\lambda t)^k / k! \quad k = 0, 1, 2, \dots \quad (10)$$

The above equation represents the Poisson process which is the probability distribution of a random variable k , representing the number of successes occurring in a given time interval.

The BER performance of the PLC channel through impulsive noise and turbo coding shown in Figure 10, can be broken down into 2 main regions [17]:

- Non convergence region, as the BER decreases gradually to a certain value of SNR, it is known as the convergence threshold.
- At the convergence threshold however, as the slope of the curve enters the waterfall region, it changes abruptly.

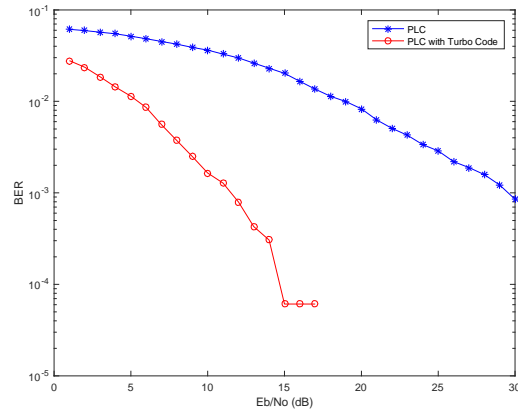

Figure 10: BER performance of the PLC channel through impulsive noise and Turbo Coding

By introducing the turbo codes, the system performance has improved as shown from Figure 10. One can see clearly that the use of turbo codes has improved the performance of the systems, for example, for a given S/N ratio of 12 dB the BER rate was shown to be 0.03 compared to a value of 0.0008 for the result with turbo codes. This will give an improvement of 0.03, which can also be written as 3×10^{-2} .

9.3 Integrated channel modelling

The BER performance of the PLC and VLC channel through AWGN and turbo coding, is shown in Figure 11. Also, the PLC channel has been simulated by adding the asynchronous impulse noise, whereas in the case of the wireless channel, it was simulated by adding the AWGN. Consequently, by observing the outcome on the simulated graph, it can be shown and concluded that through addition of turbo codes, BER

vs SNR was minimised. Nevertheless, as the SNR value increases a better BER rate was achieved.

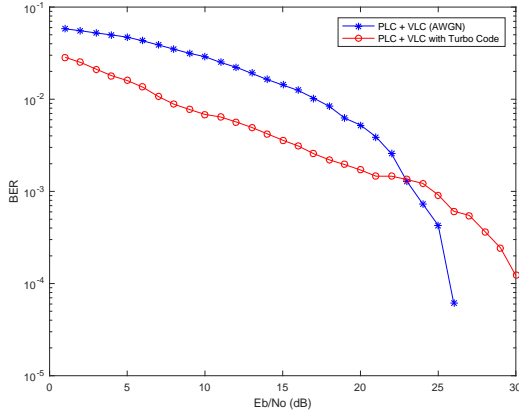

Figure 11: BER performance of the PLC and VLC channel through AWGN and Turbo Coding

It can be seen based from graph above shown in Figure 11, an improvement has been achieved through addition of Turbo codes, for example, for given S/N ratio of 10 dB the BER rate was shown to be 0.02899 compared to a value of 0.006836 for the result with turbo codes. This will give an improvement of 0.022154, which can also be written as 2.2154×10^{-2} . The integrated block diagram shown below in Figure 12 is based on OFDM PLC and VLC, where the subcarriers are designed to be orthogonal. This allows subcarriers to overlap and save bandwidth, thus achieving a higher data rate. The signals are transmitted to the powerline through the coupling, hence, a PLC to VLC conversion module in the LED illumination fixture to receive the data signal from the power line. Followed to the pre-compensation and the amplification, the LED lamps acts as an optical transmitter to cover the indoor area, where the data signal is added to the DC bias of the LED [3, 14]. At the receiver side,

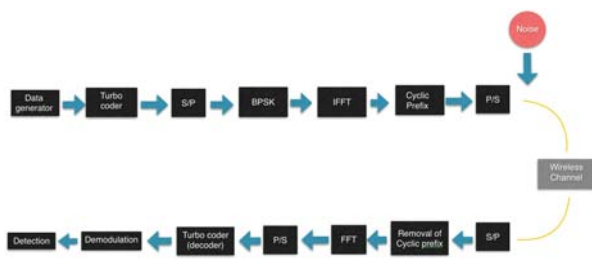

Figure 12: Simulated integrated block diagram

the light from the LED is received through an avalanche photo diode (APD). Next, according to the signal level of the received light, the OFDM signal is amplified and demodulated. Considering the overall structure of the system, the VLC is used as a down link whereas, the uplink could be established by the infrared channel or PLC, which will be well matched for the multimedia data traffic [1, 3].

10 Practical Implementation

The Mamba NB-PLC shield was utilised for the PLC, which allows the Arduino UNO shown in Figure 13, to gain access to the convenient network for data transmission. The Mamba shield developed by Link Sprite has been pre-built with a FSK modulation and is designed to work under 11/240V, 50/60Hz supply [12]. The code was designed to transmit and receive data serially. In this work, two of both, the Arduino UNO and Mamba shield were utilised by programming each of them respectively as a transmitter and a receiver.

The first test resided on sending messages from one PLC emitter, to the other PLC as a receiver. Having both of the NB-PLC shields joined by two wires which aided as the transmission medium, and hence since they are in direct contact for transmission, there is no DC current, but the signal transmitted by the shields. The Arduino UNO is powered by the USB connected to the PC, where it is the main source for data generation.



Figure 13: Two Mamba shields connected directly by two wires

11 Conclusion and Future Work

This paper in depth has provided the analysis of the Integrated Broadband Power Line (PLC) and Visible Light Communication (VLC) system using OFDM and Turbo Coding. The graphs simulated in Chapter 8, has made it vivid and conspicuous to the theory and the aim for turbo coding. Further, the results achieved simulating the PLC channel in comparison to [17] is almost similar, and yet better if compared with the same modulation technique for which we have used and that is the BPSK for the PL channel, with and without turbo codes. Also, due to the numerous amount of simulation for the which has been done to simulate both channels respectively, as the SNR ratio increases the less the BER. Nevertheless, having both systems integrated and simulated, we were able to meet the objective and that is minimising the BER rate in the channel with the addition of turbo codes, in comparison to [13].

In conclusion, none of the previous work has been done in the area of using BPSK modulation and having it integrated with PLC and VLC systems through OFDM and turbo coding. However, integrating the simulated systems through OFDM and Turbo coding has been achieved based on [11] and [3].

References

- [1] J. Song, S. Member, W. Ding, F. Yang, S. Member, and H. Yang, "An Indoor Broadband Broadcasting System Based on PLC and VLC," vol. 61, no. 2, pp. 1–10, 2015.
- [2] Y. Tanaka, S. Haruyama, and M. Nakagawa, "Wireless optical transmissions with white colored LED for wireless home links," *Pers. Indoor Mob. Radio Commun. 2000. PIMRC 2000. 11th IEEE Int. Symp.*, vol. 2, pp. 1325–1329 vol.2, 2000.
- [3] S. E. Alavi, H. Rezaie, A. Sahmah, and M. Supa, "Application of OFDM on Integrated System of Visible Free Space Optic with PLC," *Proc. 2010 IEEE Asia-Pacific Conf. Appl. Electromagn.*, no. Apace, pp. 1–5, 2010.
- [4] J. Meng and A. E. Marble, "Effective Communication Strategies for Noise-Limited Power-Line Channels," *IEEE Trans. Power Deliv.*, vol. 22, no. 2, pp. 887–892, 2007.
- [5] J. Anatory, N. Theethayi, and R. Thottappillil, "Effects of Multipath on OFDM Systems for Indoor Broadband Power-Line Communication Networks," *IEEE Trans. Power Deliv.*, vol. 24, no. 3, pp. 1190–1197, 2009.
- [6] S. M. L. Rahman and S. P. Majumder, "Performance Analysis of a Power Line Communication System with Multi-Carrier DS-CDMA," vol. 1, 2014.
- [7] M. Bogdanovi, "Power line Communication System Modeling Based on Coded OFDM," pp. 760–764, 2012.
- [8] M. Kavehrad, Z. Hajjarian, and A. Enteshari, "Energy-efficient broadband data communications using white LEDs on aircraft powerlines," *2008 Integr. Commun. Navig. Surveill. Conf.*, pp. 1–8, 2008.
- [9] T. Komine and M. Nakagawa, "Integrated system of white LED visible-light communication and power-line communication," *IEEE Int. Symp. Pers. Indoor Mob. Radio Commun. PIMRC*, vol. 4, pp. 1762–1766, 2002.
- [10] M. N. Toshihiko Komine, Shinichiro Haruyama, "Performance Evaluation of Narrowband OFDM on Integrated System of Power Line Communication and Visible Light Wireless Communication," *2006 1st Int. Symp. on Wireless Pervasive Comput.*, 2006.
- [11] K. P. Pujapanda, "LiFi integrated to power-lines for smart illumination cum communication," *Proc. - 2013 Int. Conf. Commun. Syst. Netw. Technol. CSNT 2013*, pp. 875–878, 2013.
- [12] A. D. Familua, A. R. Ndjiongue, K. Ogunyanda, L. Cheng, H. C. Ferreira, and T. G. Swart, "A Semi-Hidden Markov Modeling of a Low Complexity FSK-OOK In-House PLC and VLC Integration," *IEEE Int. Symp. Power Line Commun. Its Appl.*, pp. 199–204, 2015.
- [13] A. Rajesh and R. Nakkeeran, "Performance Analysis of Integrated System under Impulse Noise and Multipath Channel using Turbo Coded OFDM," *Adcom 2008 16th Int. Conf. Adv. Comput. Commun.*, pp. 254–259, 2008.
- [14] S. E. Alavi and S. M. Idrus, "Integrated System of Visible Free Space Optic with PLC," no. December, pp. 271–275, 2009.
- [15] C. Berrou and A. Glavieux, "Near optimum error correcting coding and decoding: Turbo-codes," *IEEE Trans. Commun.*, vol. 44, no. 10, pp. 1261–1271, 1996.
- [16] A. M. Cruz, R. B. Fernandez, J. L. O. Rodriguez, and G. A. L. Sanchez, "Low Complexity Turbo Code Specification for Power-Line Communication (PLC)," *2011 IEEE Electron. Robot. Automot. Mech. Conf.*, pp. 349–354, 2011.
- [17] K. . Heetun and B. Rajkumarsingh, "Turbo Codes and FSK in Power Line Communication," *Africon 2013*, pp. 381–386, 2013.
- [18] M. Zimmermann and K. Dostert, "An Analysis of the Broadband Noise Scenario in Powerline Networks."
- [19] A. Cort, D. Luis, F. J. Ca, and J. Jos, "Analysis of the Indoor Broadband Power-Line," vol. 52, no. 4, pp. 849–858, 2010.
- [20] E. C. Kim, I. Member, J. Heo, I. Member, J. Y. Kim, and I. S. Member, "Double Binary Turbo Coding for High Speed Power Line Communication Systems," pp. 2–3, 2010.
- [21] S. H. Lee and J. K. Kwon, "Turbo code-based error correction scheme for dimmable visible light communication systems," *IEEE Photonics Technol. Lett.*, vol. 24, no. 17, pp. 1463–1465, 2012.
- [22] Z. Ghassemlooy, W. Popoola, and S. Rajbhandari, *Optical Wireless Communications: System and Channel Modelling with MATLAB®*.
- [23] M. Katayama, "Introduction to Robust, Reliable, and High-Speed Power-Line Communication Systems."
- [24] D. Reception, "Performance Improvement of a Power Line Communication System Using OFDM Under the Effect of Fading and Impulsive Noise with," 2011.
- [25] V. Saymyydv, "Indoor Hospital Communication Systems: An integrated solution based on Power Line and Visible Light Communication," 1812.



Nader Nassar is in the final year of his B.S Degree in Telecommunication Engineering at the University of Wollongong. His professional memberships include the following but not limited to; Institute of Electrical and Electronics Engineers (IEEE), Engineers Australia, and AIESEC.



Nidhal Abdulaziz is currently working as Associate Professor at the Faculty of Engineering and Information Sciences,

University of Wollongong in Dubai. Before that she was the Director for Electronics and Electrical Engineering, Heriot Watt University (HWU) Dubai Campus, she has received her PhD from Monash University, Australia, in Electrical and Computer Systems Engineering.